



**Good Innovation**  
For Your Medical Aesthetic Needs

**INNOVATIVE  
MEDICAL  
AESTHETIC  
SYSTEM**

The starting point to your success  
**SEA HEART GROUP GENERAL CATALOG**



**SEA HEART GROUP**  
Technology for better healthcare

# SEA HEART Group Vision Story & Products

SEA HEART Group

Prioritizes customer satisfaction we are customer-oriented company thinking and acting on customer's behalf.

**SEA HEART Group**, established in 2003, has the sense of mission as a leading company in the medical aesthetic field under the business philosophy of technical innovation, customer satisfaction, right management, and pursuit of high quality at our utmost effort to provide the best solution for maintaining beauty and health.



# Contents

## PRODUCT INSTRUCTION

### MEDICAL AESTHETIC

Pigmentation Improvement / Drug Delivery Treatment  
Hair Removal / Spider Vein Removal / Face Lifting  
Acne Scar & Wrinkle Treatment

- 04 755nm, 810nm&1064nm Diode Laser - VD910
- 05 810nm Fiber Coupled Diode Laser - VD920
- 06 OPT SHR IPL - EL200
- 07 1064nm&532nm Long Pulsed Nd: YAG Laser - P100
- 09 980nm Diode Laser - VD980
- 10 10,600nm Co2 Fractional Laser - F60
- 11 Picosecond 1064nm&532nm Nd: YAG - C10
- 13 High Intensity Focused Ultrasound - HIFU-10
- 14 Fractional Microneedle RF - MR18-2S
- 15 Mesotherapy Injection - Derma Shine H8
- 16 Mesotherapy Injection - Derma Shine H1
- 17 Mesotherapy Injection - Derma Shine H2

### BODY CARE

Body Shaping / Fat Removal

- 20 4 in 1 velashape - SM 7
- 22 Cryolipolysis fat freezing slimming system - ETG D4S
- 23 2-in-1 Multi-polar RF & Vacuum slimming system - DC R30

### FACIAL CARE

Skin Tightening / Scar Treatment / Acne Treatment  
Facial Imaging System for Clinical Research

- 26 9-in-1 Hydra Dermabrasion System - SPA18
- 29 3-in-1 Special light Therapy System - Dr.Light
- 30 Facial Imaging System - Magic.Mirror 4S



# Medical Aesthetic System

MAKE YOUR LIFE BETTER, CHANGE YOUR SKIN AGE

- 
- 02 755nm, 810nm & 1064nm Diode Laser - VD910  
Hair Removal, Skin Tightening
  - 03 810nm Fiber Coupled Diode Laser - VD920  
Hair Removal, Skin Tightening
  - 04 OPT SHR IPL - EL200  
Hair Removal, Skin Tightening, Vascular Removal, Acne Treatment
  - 05 1064nm & 532nm Long Pulsed Nd: YAG Laser - P100  
Hair Removal, Vascular Lesions Treatment, Skin Tightening
  - 07 980nm Diode Laser - VD980  
Face & Leg Spider Vein Removal
  - 08 10,600nm Co2 Fractional Laser - F60  
Skin Resurfacing, Vaginal Tightening
  - 09 Picosecond 1064nm & 532nm Nd: YAG - C10  
Tattoo & Pigmentation Improvement, Acne & Wrinkle Treatment
  - 11 High Intensity Focused Ultrasound - HIFU-10  
Face Lifting, Wrinkle Removal, Anti-aging, Body Slimming
  - 12 Fractional Microneedle RF - MR18-2S  
Acne Scar & Wrinkle Treatment, Improve Pore, Pigmentation, Lifting
  - 15 Mesotherapy Injection - Derma Shine H8 - H1 - H2  
Drug Delivery (Hyaluronic acid, Botox, Placenta, Restylane, Juvederm, Theosyal, PRP and etc.)

# THE POWER OF THREE TRIO CLUSTERED DIODE LASER TECHNOLOGY FOR HAIR REMOVAL

- 3 combined wavelengths covering the optimal treatment spectrum
- Virtually painless • Proven safety record
- All skin types, even tanned skin

- ✓ 1200W 755 ALEX-810-1064 YAG Diode Laser.
- ✓ Micro Channel Technology.
- ✓ 12 x 12mm or 12 x 20mm Big Spot Size.
- ✓ ChillTip contact cooling.
- ✓ Up to 20 Milion Shots Guaranty !



THE POWER OF THREE



## ■ Thermoelectric Cooler System

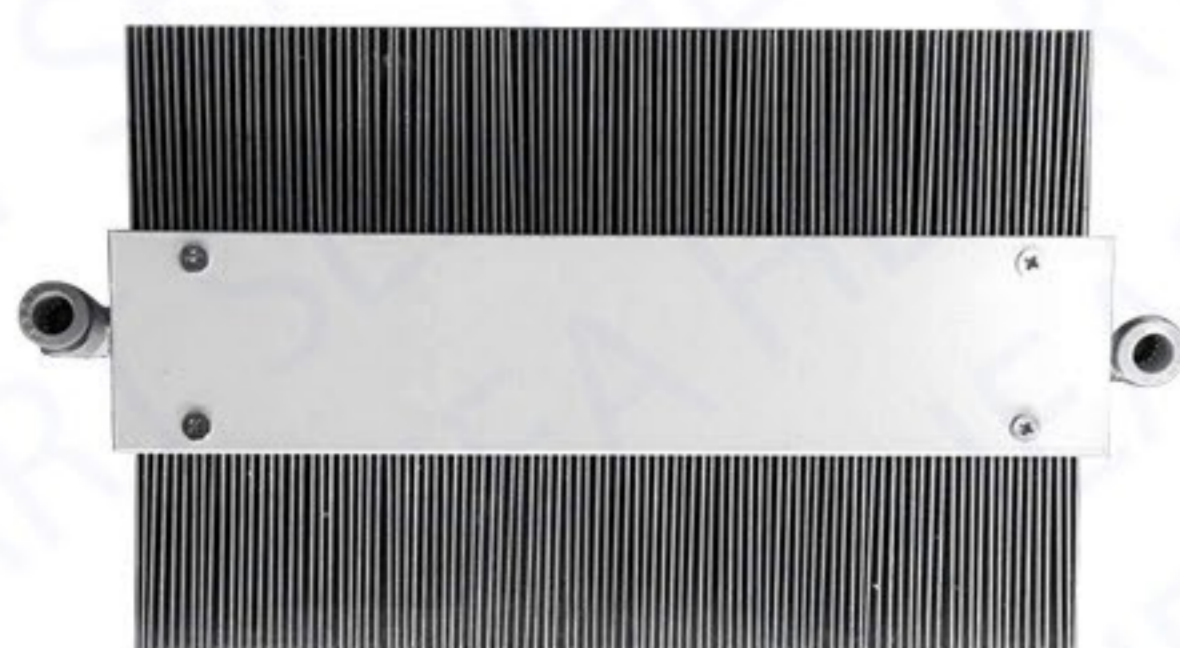

**NEW**

## POWERFUL COOLING SYSTEM Semiconductor Thermal Management System

1. The water temperature could decrease 11°C within 8 minutes.
2. The machine could work continuously for 24 hours a day without stop, more treatments permitted.
3. Constant temperature working, prolong laser & machine life, save cost.



# 200W FIBER COUPLED 808NM DIODE LASER

## TECHNOLOGY FOR HAIR REMOVAL

- Long lifetime, 25 million shots or Two yeras guarantee.
- Ultra-light handpiece. • Sapphire contact cooling.
- Easy maintenace, no need to replace filters or water regularly.
- **Uniform Energy Distribution**

Vertical laser stack    Fiber coupled diode

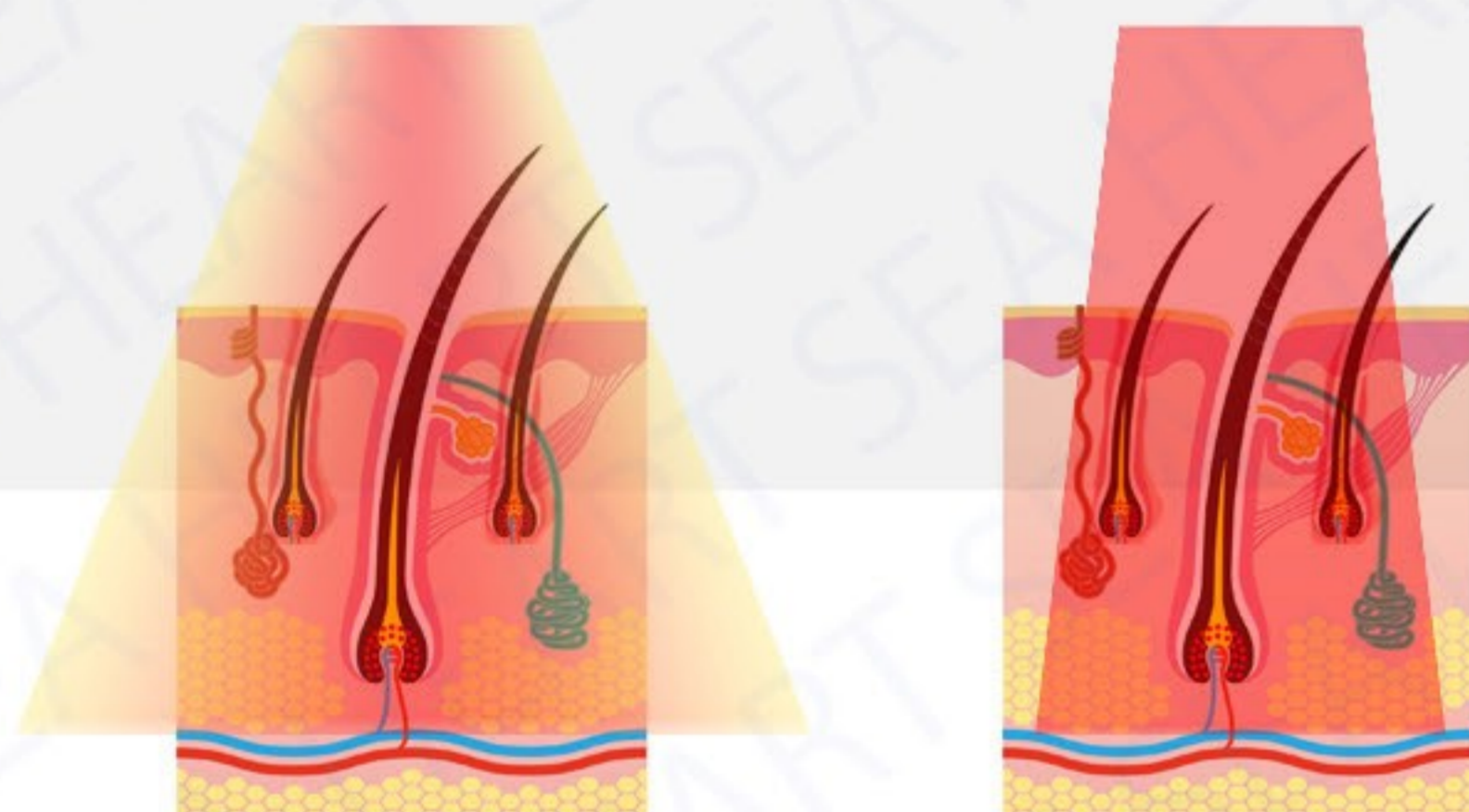

Fiber coupled diode laser is designed with a uniform energy distribution at a small divergence angle for more gentle and effective depilation.

VERTICAL LASER STACK VS FIBER COUPLED DIODE			
Laser Type	Macro channel vertical laser stack	Micro channel vertical laser stack	Fiber coupled diode laser
Laser Power	Not easy to reach high power	Easy to reach high power	Not easy to reach high power
Electric Current	High	High	Low
Water Temperature	≤ 25 °C	≤ 25 °C	≤ 45 °C
Water Quality	Deionized water	Deionized water	Clean water
Thermal damage probability	Easy damaged	Very easy damaged	Not easy damaged
Laser failure <small>By moisture condensation</small>	Yes	Yes	No
Maitenance Requirement	High <small>Replace filler, 6-12 months apart Replace water, 1 months apart</small>	High <small>Replace filler, 3-6 months apart Replace water, 1 months apart</small>	LOW <small>No need to change filter Replace water, 3 months apart</small>
Lifespan	5 ~10 million shots	15 ~20 million shots	20 ~30 million shots

# OPTIMAL PULSE TECHNOLOGY SHR HAIR REMOVAL IPL

More effective, more comfortable, has become the necessary choice to replace the outdated equipment, like IPL E-Light.

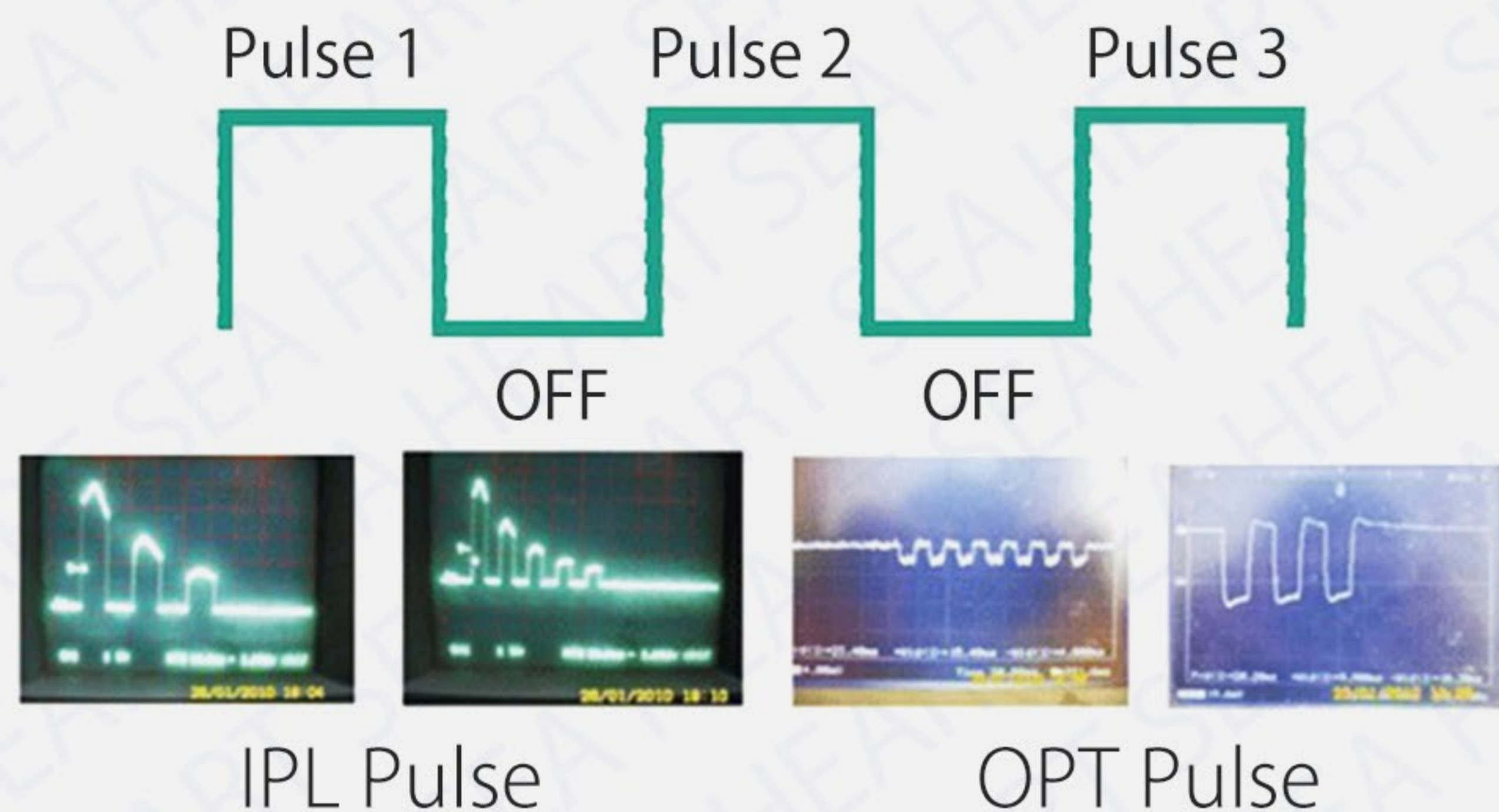

## ■ THE OPT ADVANTAGES

- Control pulse shape by equalizing energy distribution over the entire pulse or sequential pulses.
- Gentler, more comfortable, patient-friendly procedures, with lower effective fluences.
- High peak power, shorter pulses – optimal for IPL skin treatments using photorejuvenation and treatment of benign pigmented lesions.
- Advanced OPT will also allow determining the specific fluence per sub-pulse when using multiple sequential pulsing, for fine-tuned treatment settings.

## ■ CLINICAL RESULTS





# LONG-PULSED 1064nm Nd: YAG LASER

High Performance for Vascular Lesions,  
Hair Removal & Dermal Remodeling

## Contact cooling system

Make sure you feel painless & comfortable  
during the whole treatment.

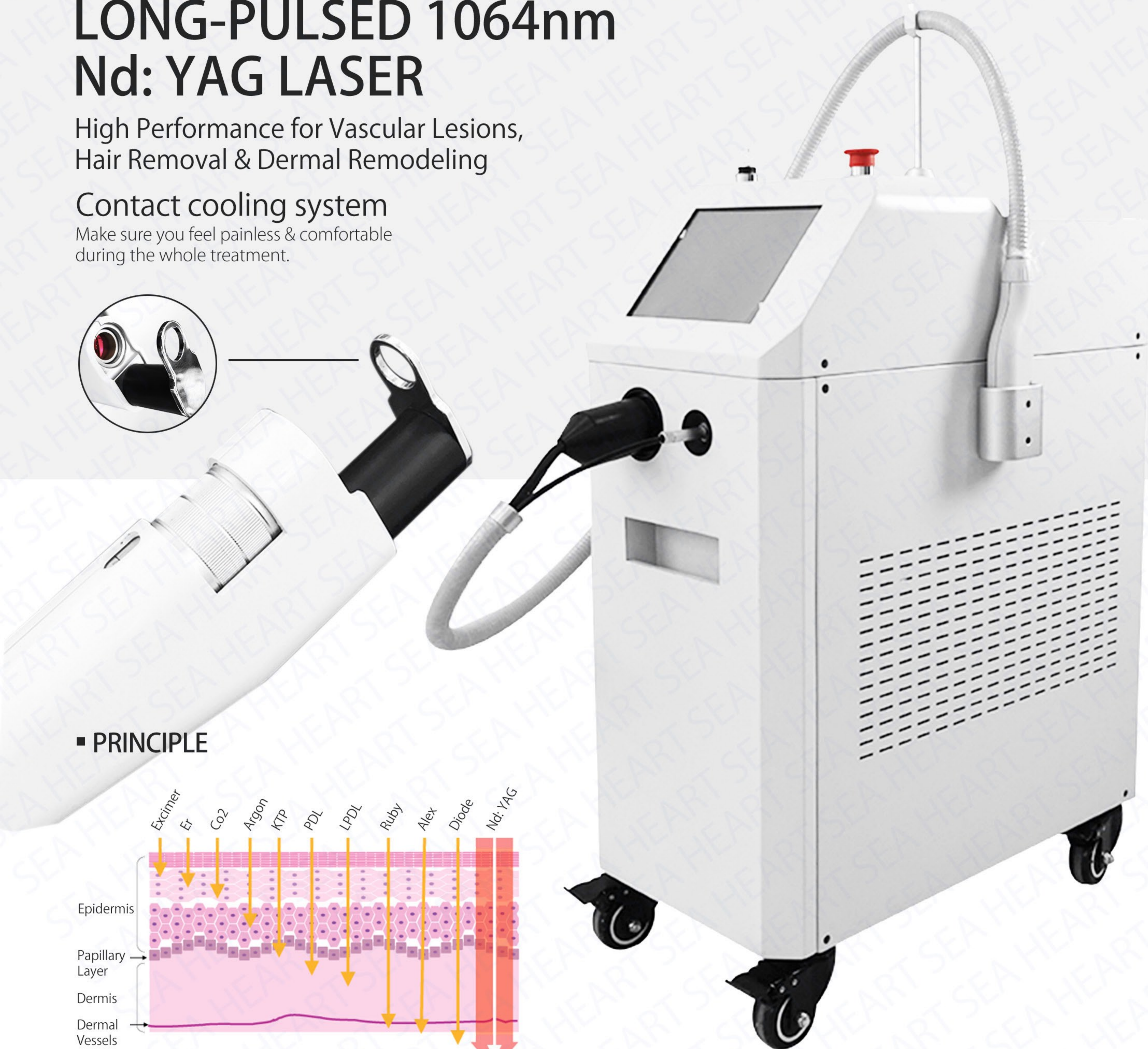

## PRINCIPLE

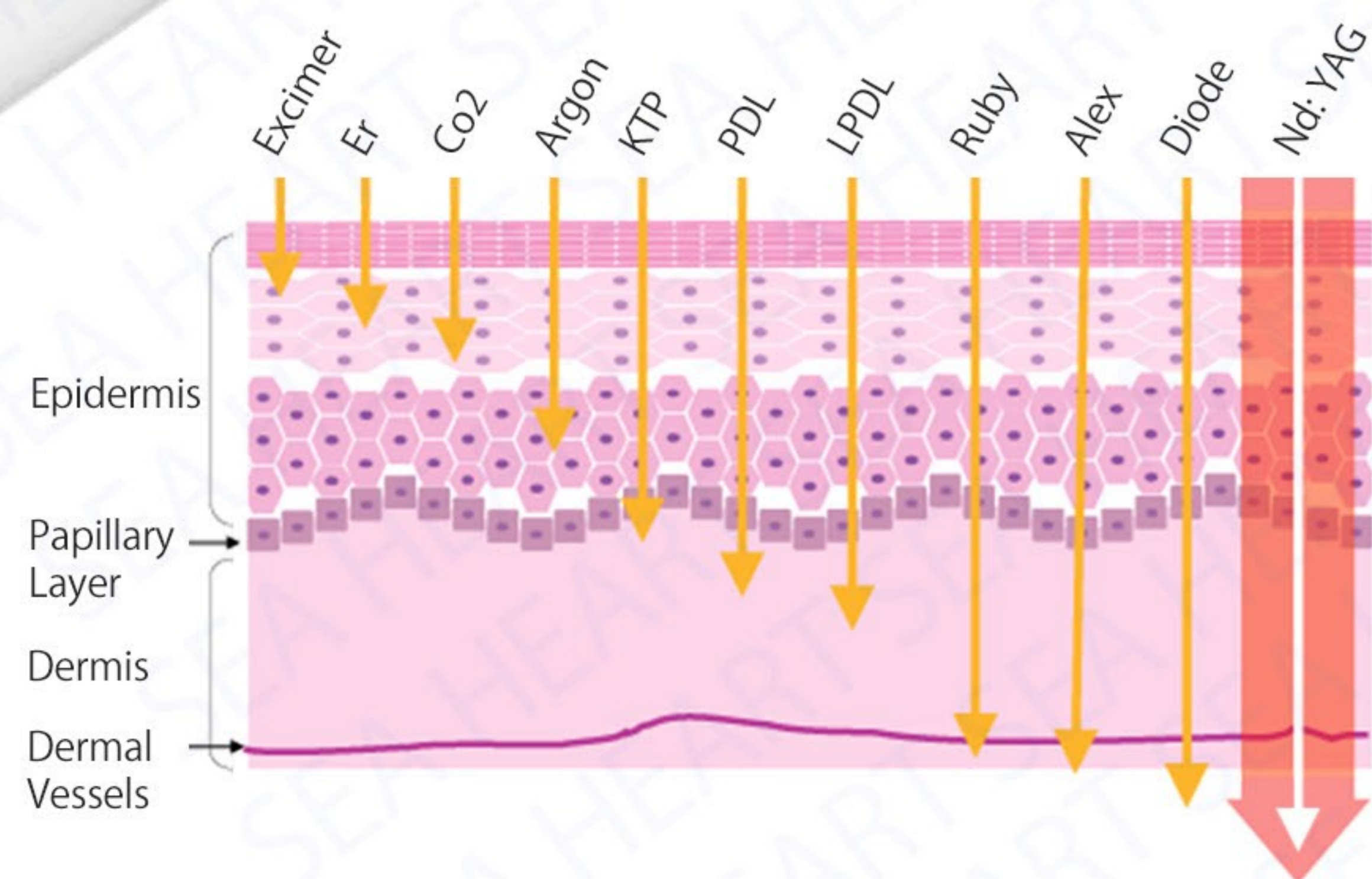

# MEDICAL AESTHETIC | BODY CARE | FACIAL CARE

## LONG PULSED ND YAG LASER & IPL PRODUCT SPECIFICATIONS

Item					
Model	LP100	EL80			
Type	Long pulsed Nd YAG laser	UK Xenon lamp IPL			
Wavelength	1064nm & 532nm	610~900nm, 530~900nm			
Peak Power	300W / 600W	800W ( OPT SHR )			
Pulse Width	30ms	10~1400ms			
Spot Size	3 ~ 15mm	HR 50x10mm, SR 40x8mm			
Fluence	Max 600J/cm2	SHR 1~10J/cm2, HR 1~50J/cm2			
Repetition Rate	0.5Hz, 1Hz, 2Hz	Up to 10Hz			
Control	8 inch, Touch screen	8 inch, Touch screen			
Lifespan	300,000 shots	300,000 shots			
Packaging	57x56x85cm, 75Kg	58x56x110cm, 50Kg			
Item					
Model	LP400S	LP400	LP300	EL200	
Type	Long pulsed Nd YAG laser	Long pulsed Nd YAG laser	Long pulsed Nd YAG laser	UK Xenon lamp IPL	
Wavelength	1064nm	1064nm	1064nm & 532nm	610~900nm, 530~900nm	
Peak Power	1000W	1000W	300W / 600W	1200W ( OPT SHR )	
Pulse Width	40ms	40ms	30ms	10~1400ms	
Spot Size	3 ~ 10mm	3 ~ 10mm	3 ~ 15mm	HR 50x10mm, SR 40x8mm	
Fluence	Up to 110j/cm2	Up to 110j/cm2	Max 600J/cm2	SHR 1~10j/cm2, HR 1~50j/cm2	
Repetition Rate	Up to 5Hz	Up to 5Hz	0.5Hz, 1Hz, 2Hz	Up to 10Hz	
Control	10 inch, Touch screen	10 inch, Touch screen	8 inch, Touch screen	8 inch, Touch screen	
Lifespan	1,000,000 shots	1,000,000 shots	300,000 shots	300,000 shots	
Packaging	97x44x102cm, 70Kg	97x44x102cm, 70Kg	57x56x110cm, 75Kg	58x56x110cm, 50Kg	

# SPIDER VEIN REMOVAL 980NM DIODE LASER

OC/OT PROTECT TECHNOLOGY  
SAFE USE AND LONG LIFE  
Work Immediately



Germany laser diode  
Stable performance  
Sufficient power



## Introduction

980nm laser is the optimum absorption spectrum of Porphyrin vascular cells. Vascular cells absorb the high-energy laser of 980nm wavelength, solidification occurs, and finally dissipated.



## Clinical Images



## Specification

Type	980nm Diode laser
Fluence	15W / 20W / 30W
Frequency	20 ~ 100ms
Cartridges	1 ~ 10Hz
Panel	8 inch, Touch screen
Packaging	51x51x46cm, 40Kg

# VAGINAL TIGHTENING CO2 FRACTIONAL LASER

For Skin Resurfacing, Skin Rejuvenation, Pigmentation Removal & Scar Treatment

- USA RF laser, high quality & excellent performance.
- Smaller focal spot, stronger penetration powerful output energy.
- Minimally invasive, virtually painless procedure & fast recover.



## ■ Vaginal Therapy Introduction

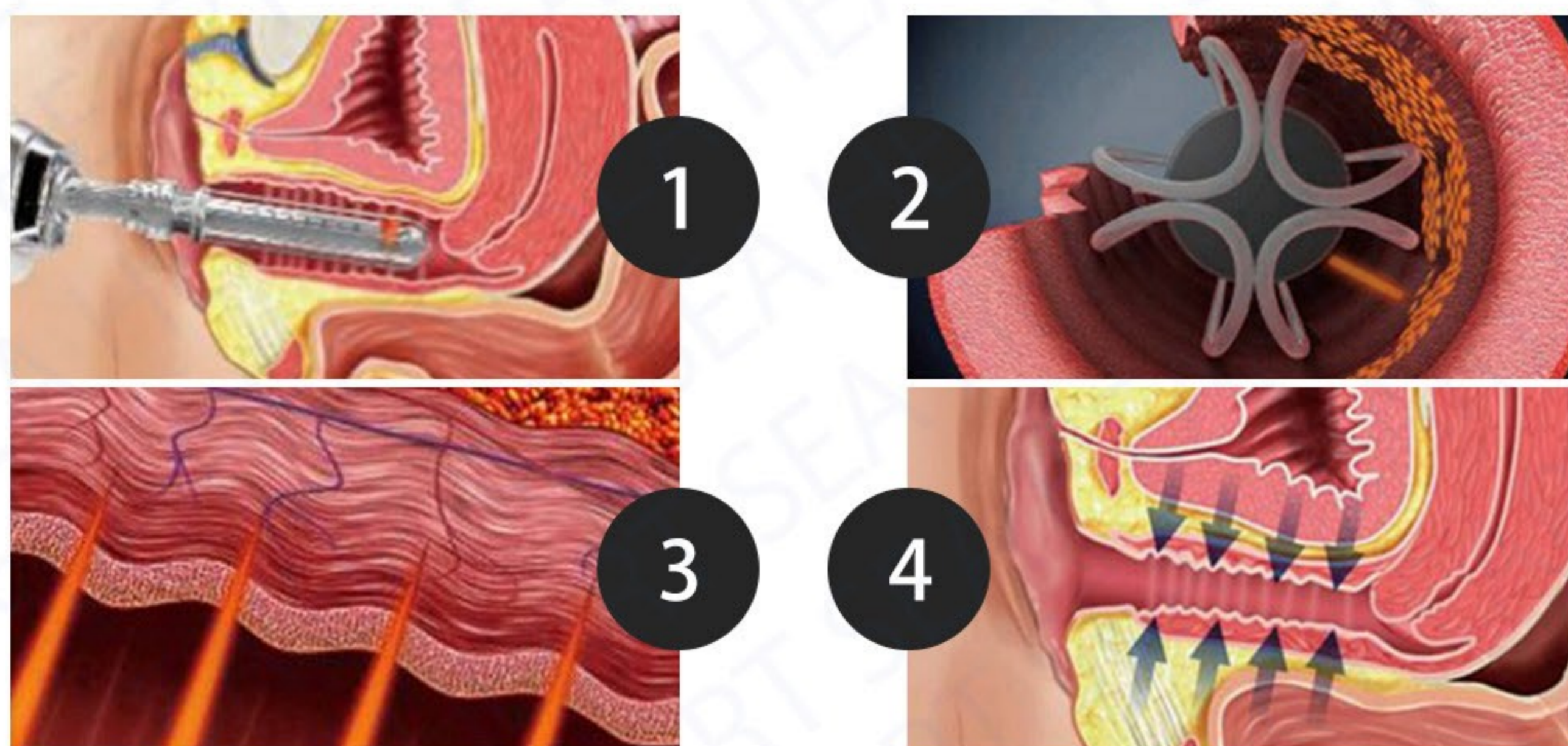

## ■ Co2 Fractional Therapy

Skin regeneration process after fractional Co2 laser

**Immediately after laser**  
Ablated epidermis & dermis

**Post 2 days**  
Re-epithelialization and collagen synthesis

**Post 14 days**  
Complete epidermal regeneration. Continuing collagen synthesis

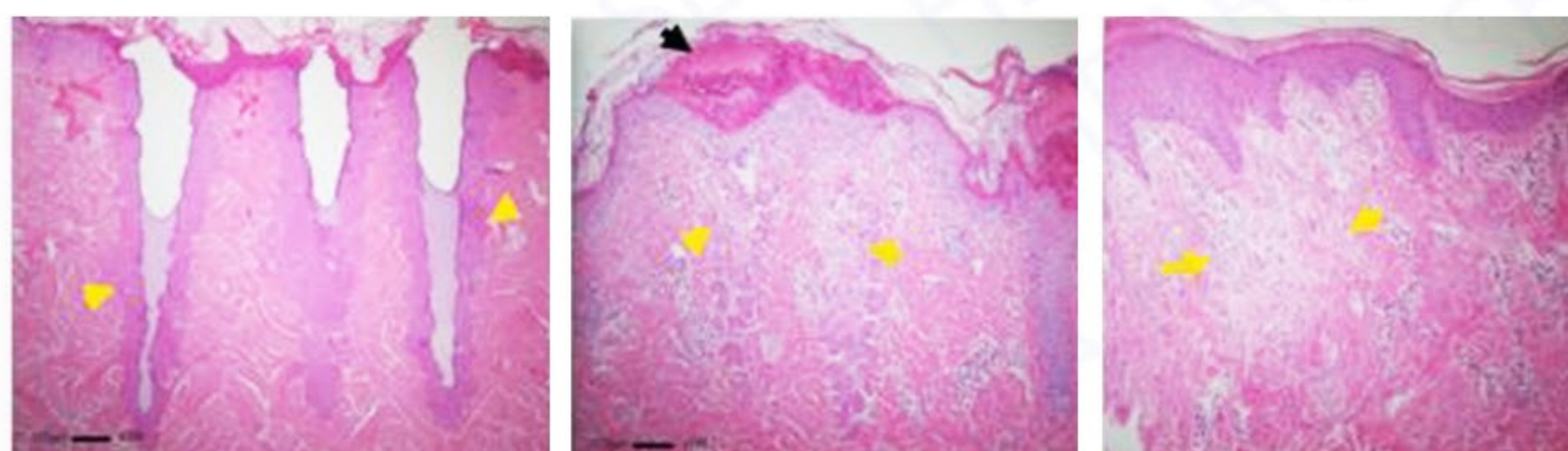

## ■ Specification

Type	10,600nm RF tube fractional Co2 laser
Power	60W
Mode	Fractional, Normal & Vaginal
Spot Size	0.11 ~ .013
Frequency	70 ~ 200Hz
Packaging	44x93x110cm, 70Kg

# PICOCARE BEYOND NANO EXPERIENCE REAL PICO

Fewer shots, faster treatment, and better efficacy  
Picosecond 1064nm & 532nm Nd:YAG Laser

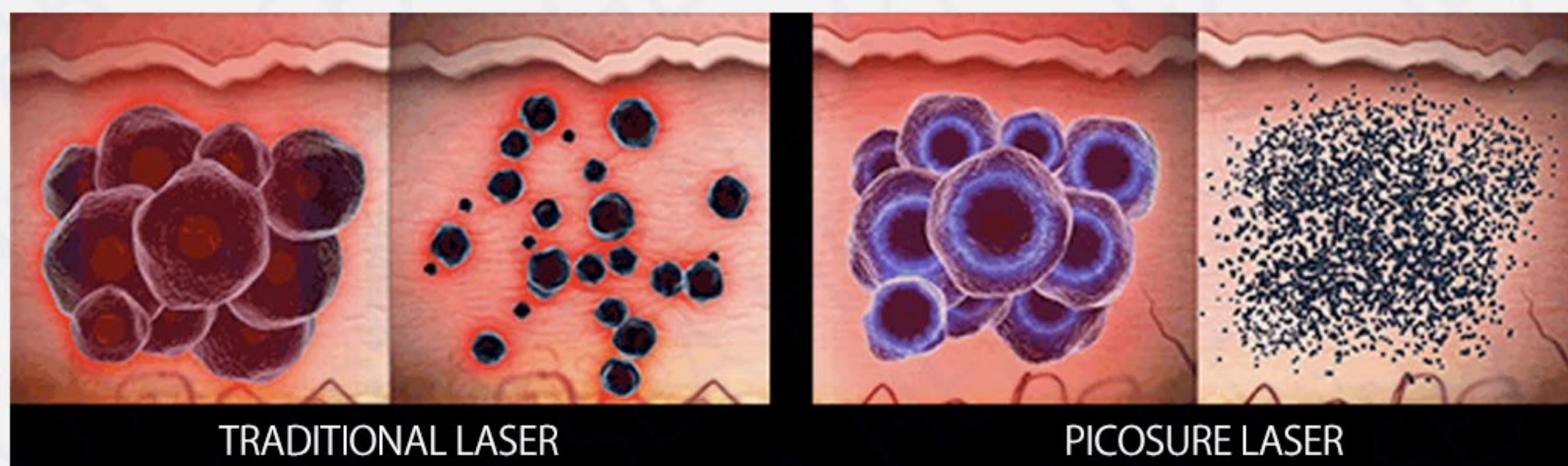

## FEATURES

- Beyond Nano, Experience Real PICO**  
 PICOCARE breaks all colors of tattoos and pigments into tiny particles by higher peak power of shorter pulse duration.
- Best Solution for Tattoo Removal**  
 PICOCARE has more photomechanical effect with less thermal effect on the skin, Bringing better results with almost no side effects in tattoo removal and pigmentation treatment
- MLA handpiece, replacing subcision**  
 MLA (Micro Lens Array) handpiece is the fractional system with high energy density in the center of each dots.

### Ultra-short Pulse Duration Is the Difference

Picosecond pulse width is 100X shorter than nanosecond technology.  
Only ultrashort pulse durations trigger photomechanical effect.  
With this short pulse width, half the fluence is required compared to Q-Switched nanosecond lasers.

### ■ NANO VS PICO Comparison between nanosecond and picosecond

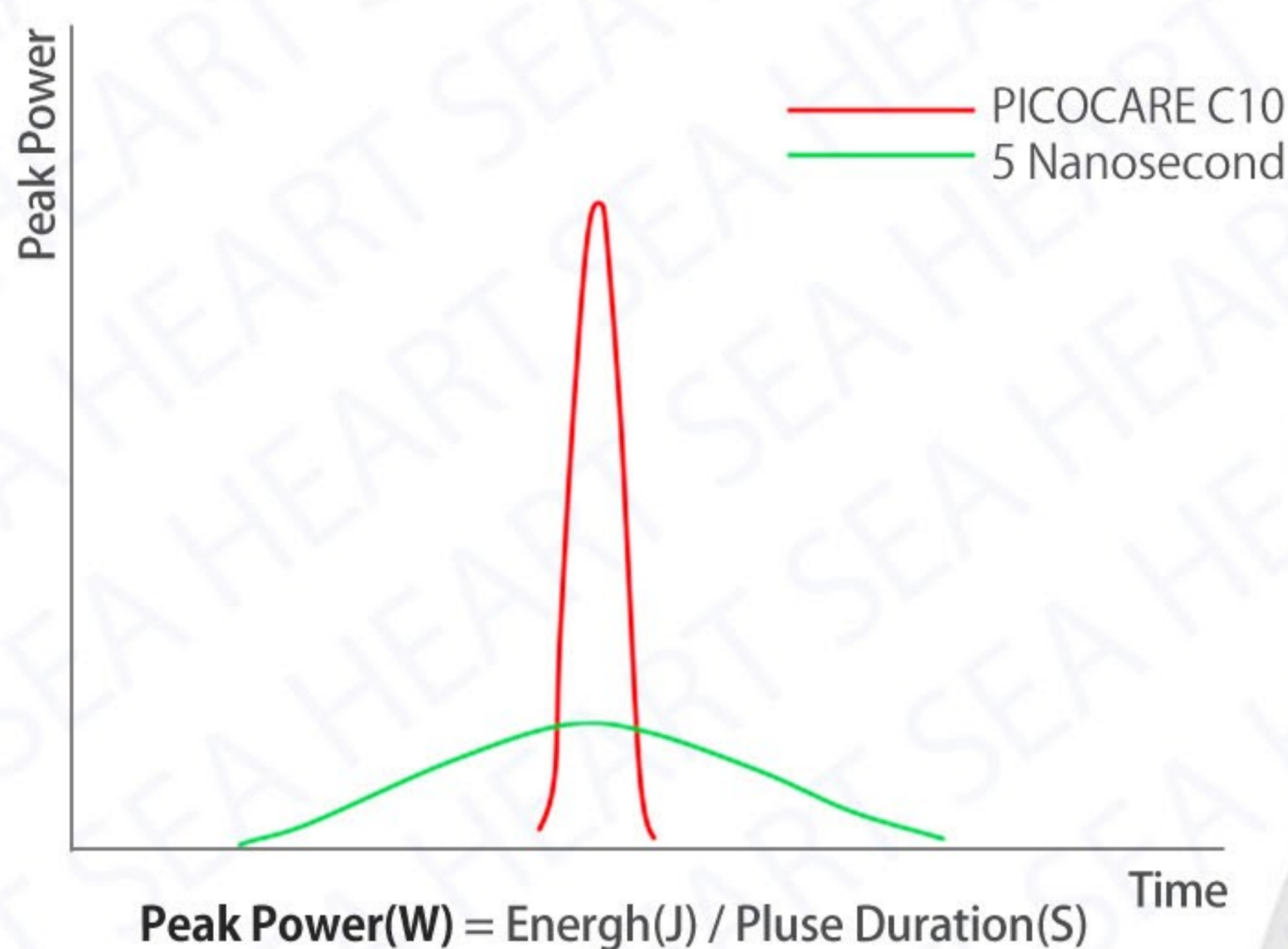

### ■ Laser Response Comparison



# MEDICAL AESTHETIC | BODY CARE | FACIAL CARE

## Nd: YAG LASER PRODUCT SPECIFICATIONS

Item				
Model	PICOCARE S10	PICOCARE C10	C9	C8
Type	Nd: YAG	Nd: YAG	Nd: YAG	Nd: YAG
Wavelength	1064nm, 532nm	1064nm, 532nm	1064nm, 532nm	1064nm, 532nm
Output	600mJ(1064nm), 300mJ(532nm)	700mJ(1064nm), 350mJ(532nm)	1500mJ(1064nm), 750mJ(532nm)	1200mJ(1064nm), 600mJ(532nm)
Pulse Width	450ps	800ps	≤8ns	≤8ns
Power	1.33GW(1064nm), 0.8GW(532nm)	0.87GW(1064nm), 0.37GW(532nm)	0.18GW(1064nm), 0.09GW(532nm)	0.15GW(1064nm), 0.07GW(532nm)
Spot Size	Zoom H/P: 2 to 10mm MLA H/P: 7x7mm, 9x9mm	Zoom H/P: 2 to 10mm MLA H/P: 7x7mm, 9x9mm	Zoom H/P: 2 to 10mm MLA H/P: 7x7mm, 9x9mm	Zoom H/P: 2 to 10mm MLA H/P: 7x7mm, 9x9mm
Repetition Rate	Single, Up to 10Hz	Single, Up to 10Hz	Single, Up to 10Hz	Single, Up to 10Hz
Control	10.4 inch, Touch screen	10.4 inch, Touch screen	10.4 inch, Touch screen	10.4 inch, Touch screen
Packaging	60x110x130cm, 110Kg	110x60x130cm, 110Kg	110x41x120cm, 88Kg	110x40x120cm, 78Kg
Item				
Model	C5	C5P		
Type	Nd: YAG	Nd: YAG		
Wavelength	1064nm, 532nm	1064nm, 532nm		
Output	200mJ(1064nm), 100mJ(532nm)	200mJ(1064nm), 100mJ(532nm)		
Pulse Width	≤20ns	≤20ns		
Power	500W	500W		
Repetition Rate	Single, Up to 10Hz	Single, Up to 10Hz		
Control	Control Panel	Control Panel		
Packaging	60x34x36cm, 18Kg	57x32x42cm, 15Kg		

# NEW ANTI-AGING CONCEPT - HIFU

ONE COURSE  
YOUTHEN 3 - 5 YEARS

Disclose Stars' Infinitely Young Secret

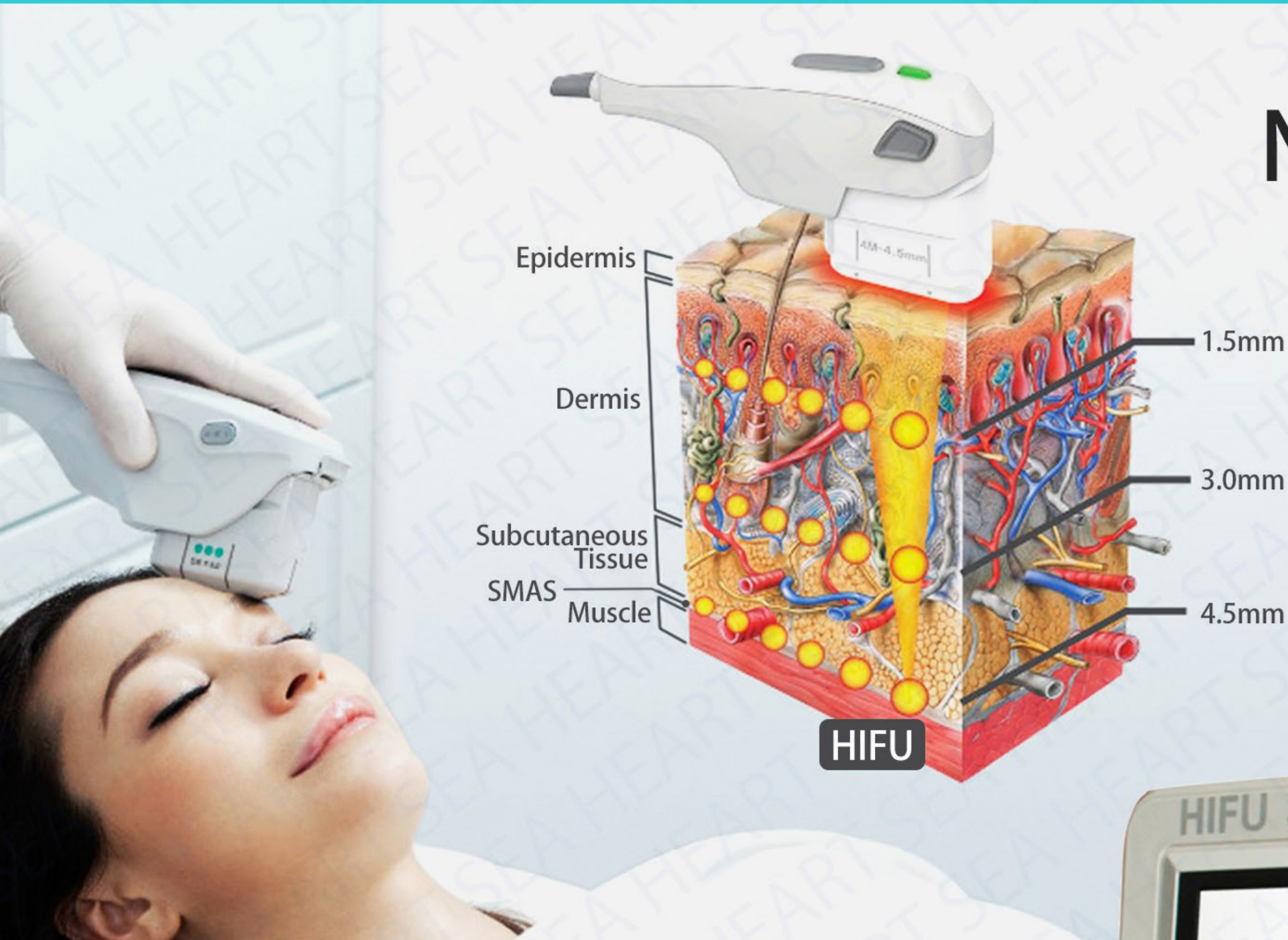

## CARTRIDGE

### Optimized cartridges in 3 different types

Convenient device but powerful energy density at focused area leads to superior results.



DS 13mm  
Fat Reduction

DS 4.5mm  
SMAS

DS 3.0mm  
Deep Dermis

### Clinical Images



### Specification

Type	High Intensity Focused Ultrasound - HIFU
Fluence	0.1 ~ 2.0J/cm <sup>2</sup> (0.1 step)
Frequency	7MHz ( 3.0mm ), 4MHz ( 4.5mm ), 1MHz ( 13mm )
Cartridges	3.0mm, 4.5mm, 13mm
Panel	15inch, Touch screen
Packaging	46x38x20cm, 10Kg

# MICRO-NEEDLING FRACTIONAL RF SYSTEM

Reduce acne scars, fine lines & wrinkles and rejuvenate your skin

CRYO + MRF + SRF

Microneedle fractional RF - MRF

Superficial fractional RF - SRF

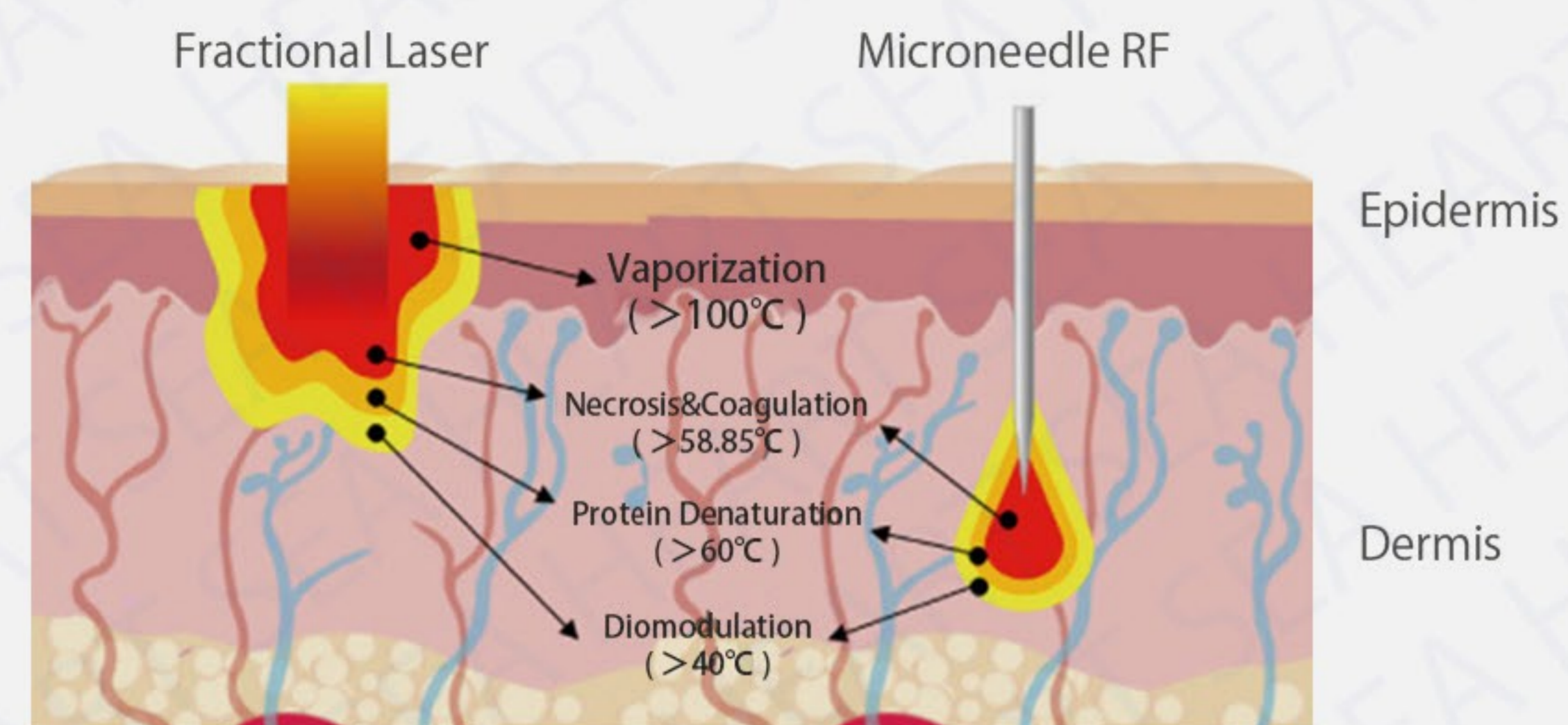

## How Does It Work? Mironeedle Fractional RF - Working Sketch Map

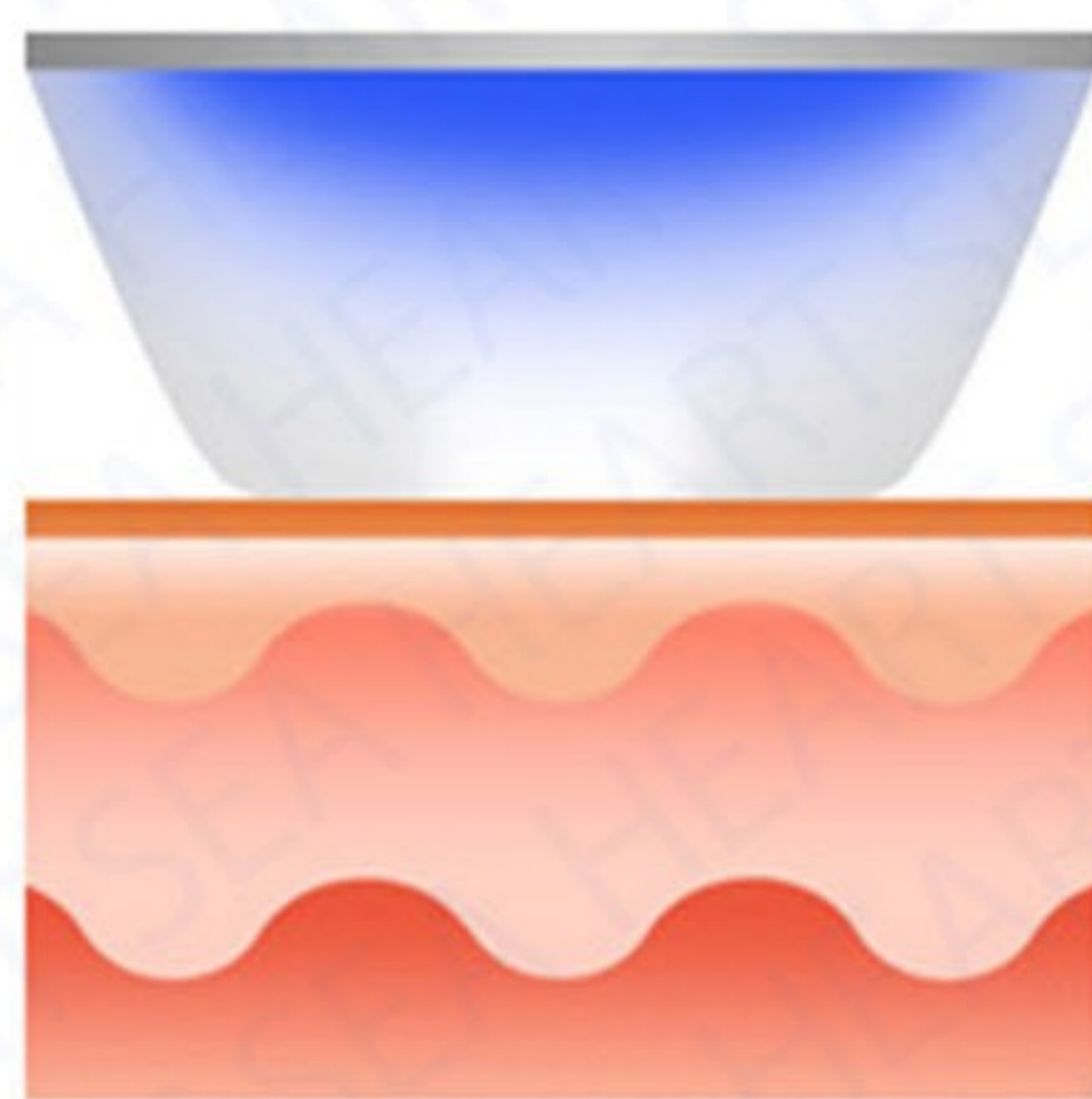

**1** Micro-needle cartridge makes perfect contact to the skin.

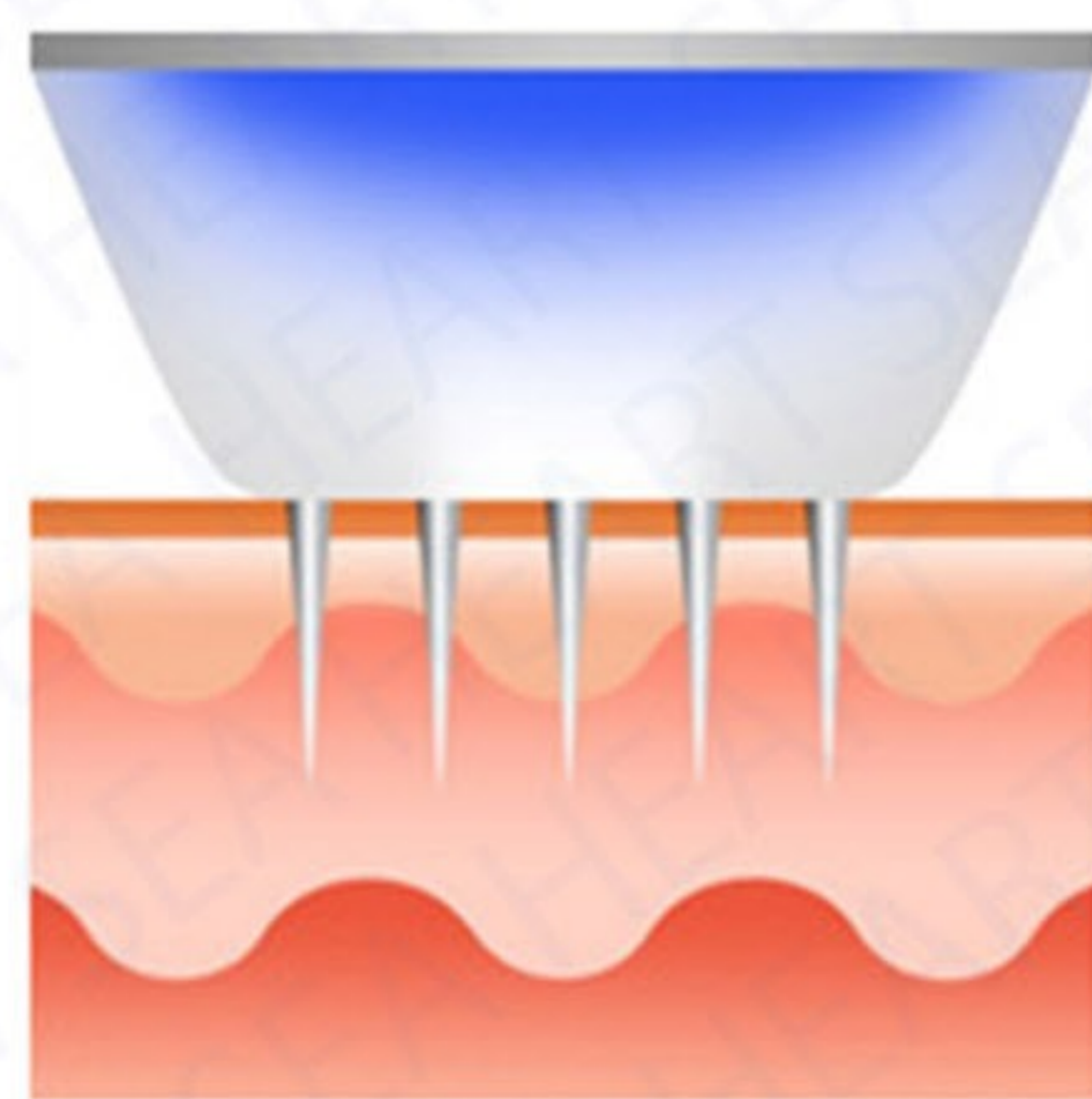

**2** Micro-needle smoothly penetrate the skin with less pain.

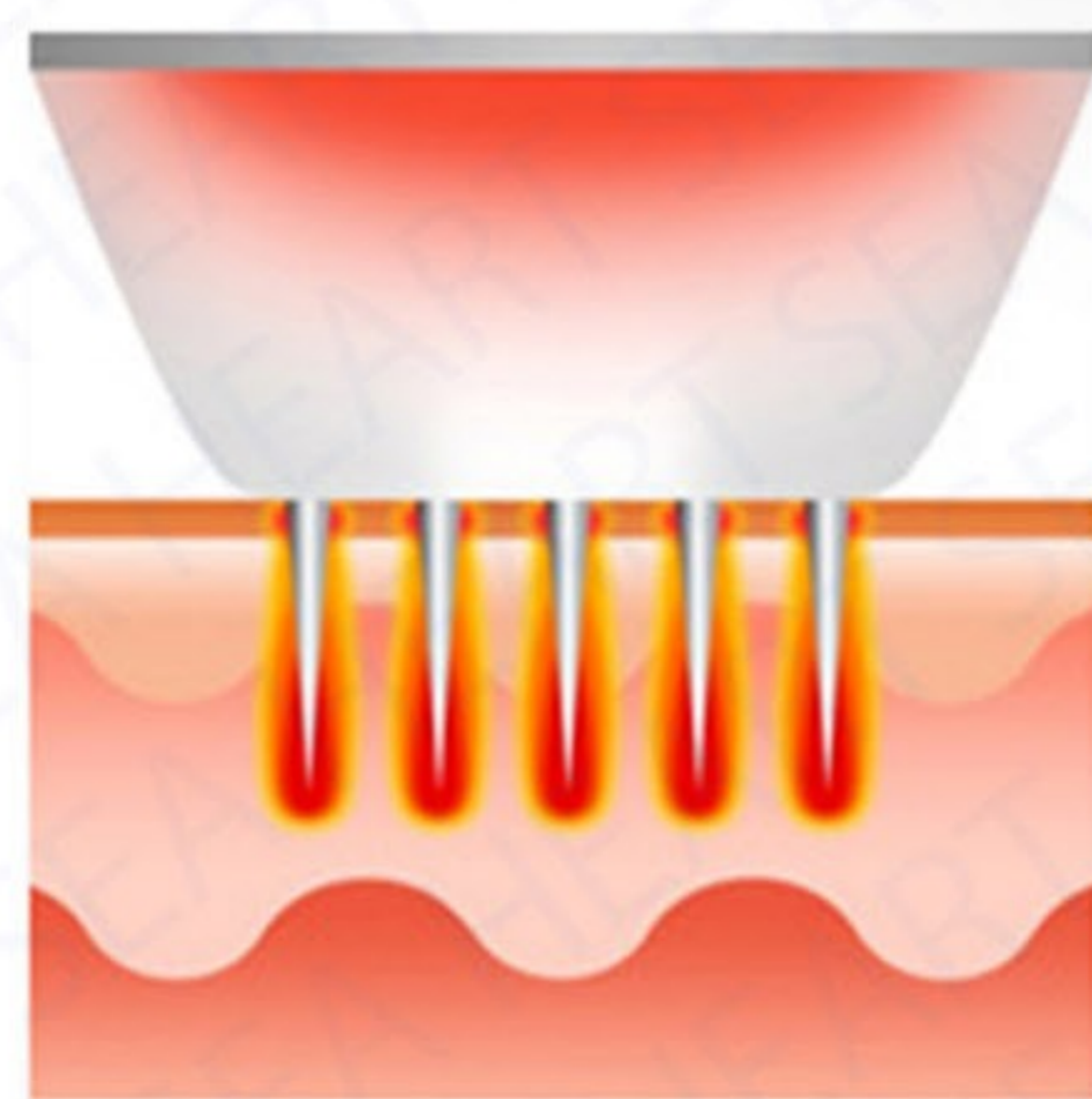

**3** Bipolar RF energy denaturalizes the tissues surrounding the micro needles.

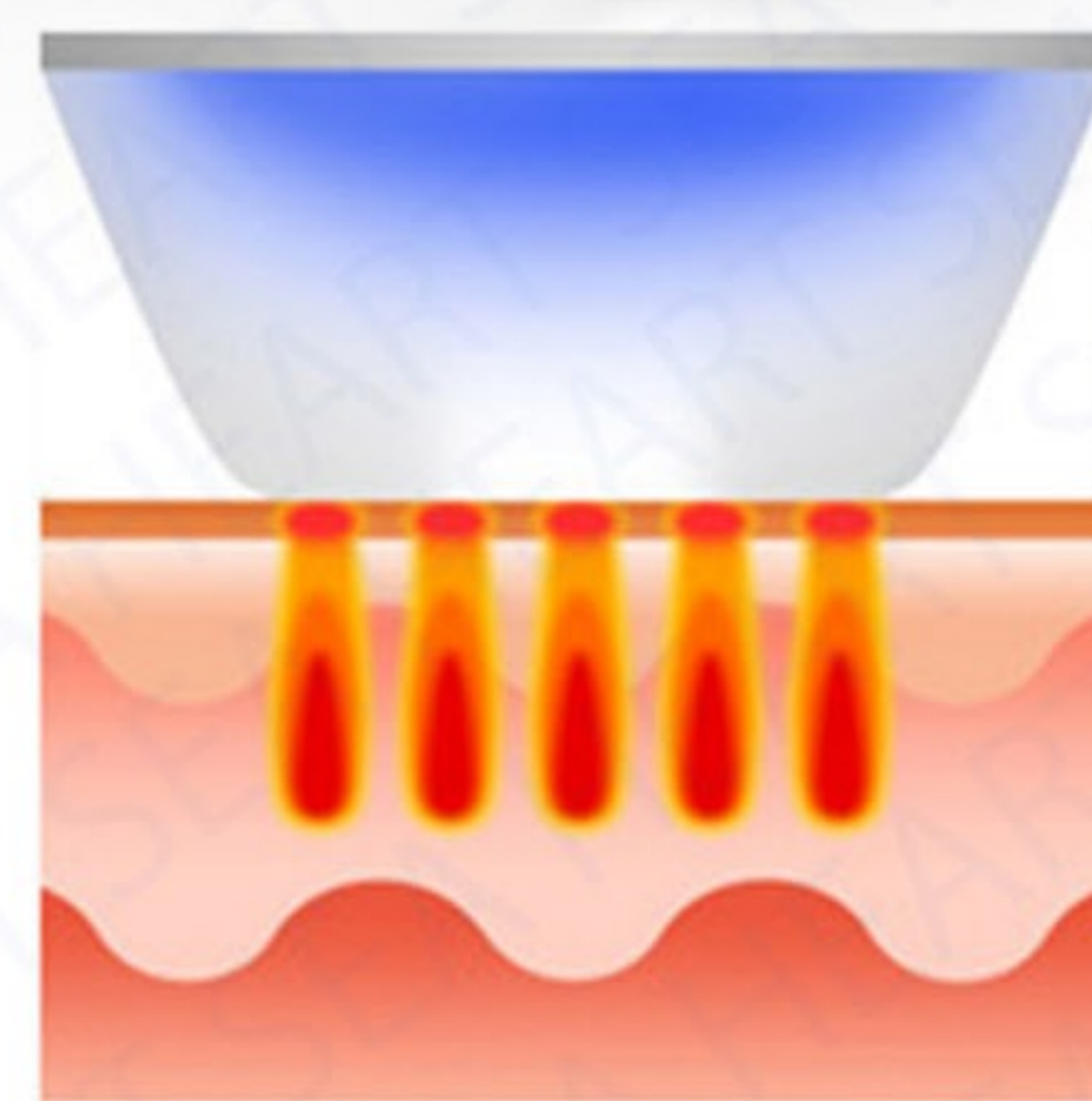

**4** Collagen regeneration & new elastic production process begins.

## Clinical Images Acne : After 3 Session



## Specification

Type	Microneedle RF + Superficial RF + PDT +CRYO
Frequency	5MHz
Fracitonal Needle	81pin, 49pin, 25pin
Needle Depth	0.25 ~ 3.00mm, Auto mode adjusting depth
Cryo Temperature	-5°C
Packaging	48x30x110cm, 30Kg



*Blooming your face*

# AUTO INJECTION SYSTEM INTROFILL INJECTOR

Safer, easier & faster drug delivery system

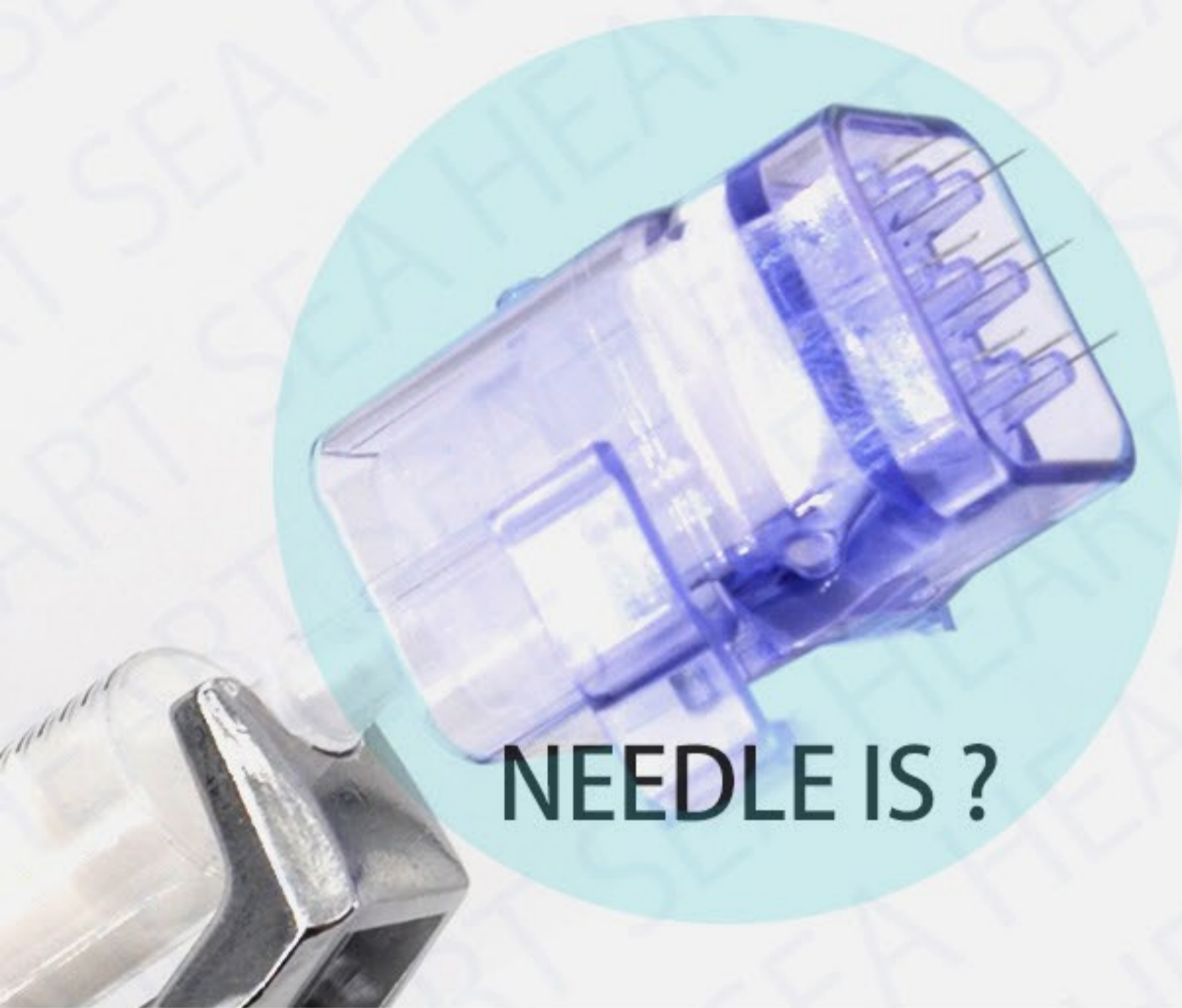

## NEEDLE TYPE

32G thickness 9 needle cartridge

## NEEDLE DEPTH/LENGTH

0 ~ 4.0mm



## WHAT ARE THE BENEFITS FOR MY SKIN?

Smoothing  
Tightening  
Reduces pore size  
Softens wrinkles  
Hydrates

**INTROFILL H8**

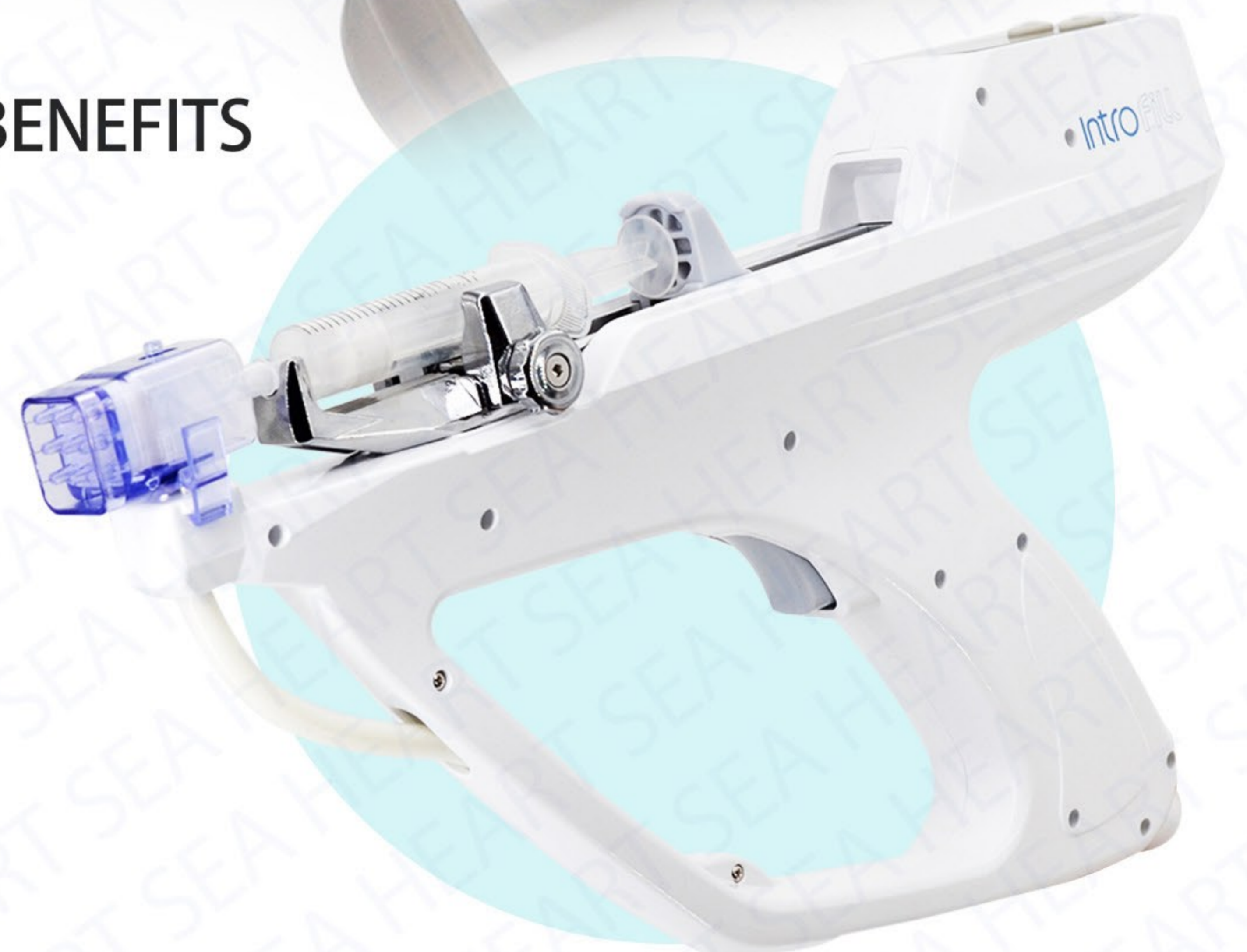

# VITAL INJECTOR I

Safer, Easier and Faster drug delivery system

- Minimizes Drug Loss
- User Convenient Program
- Safe Treatment Available
- Accurate Treatment Available



## INCORPORATING THE LATEST TECHNOLOGY VACUUM ASSISTED NEEDLE

Newly engineered needle delivers all the essential functionality to meet the clinical needs

- **Pressure release**  
Needle enables to inject all needles beneath skin and subcutaneous tissue minimize drug loss.
- **Controlled depth adjustment**  
From 0 ~ 5mm at 0.2mm interval, delivers customized treatment to accurately target sub dermis where most of collagen and elastin exists.
- **31G 5Pins multi needle**  
Provides dynamically faster treatment.

## VACUUM ASSISTED NEEDLE

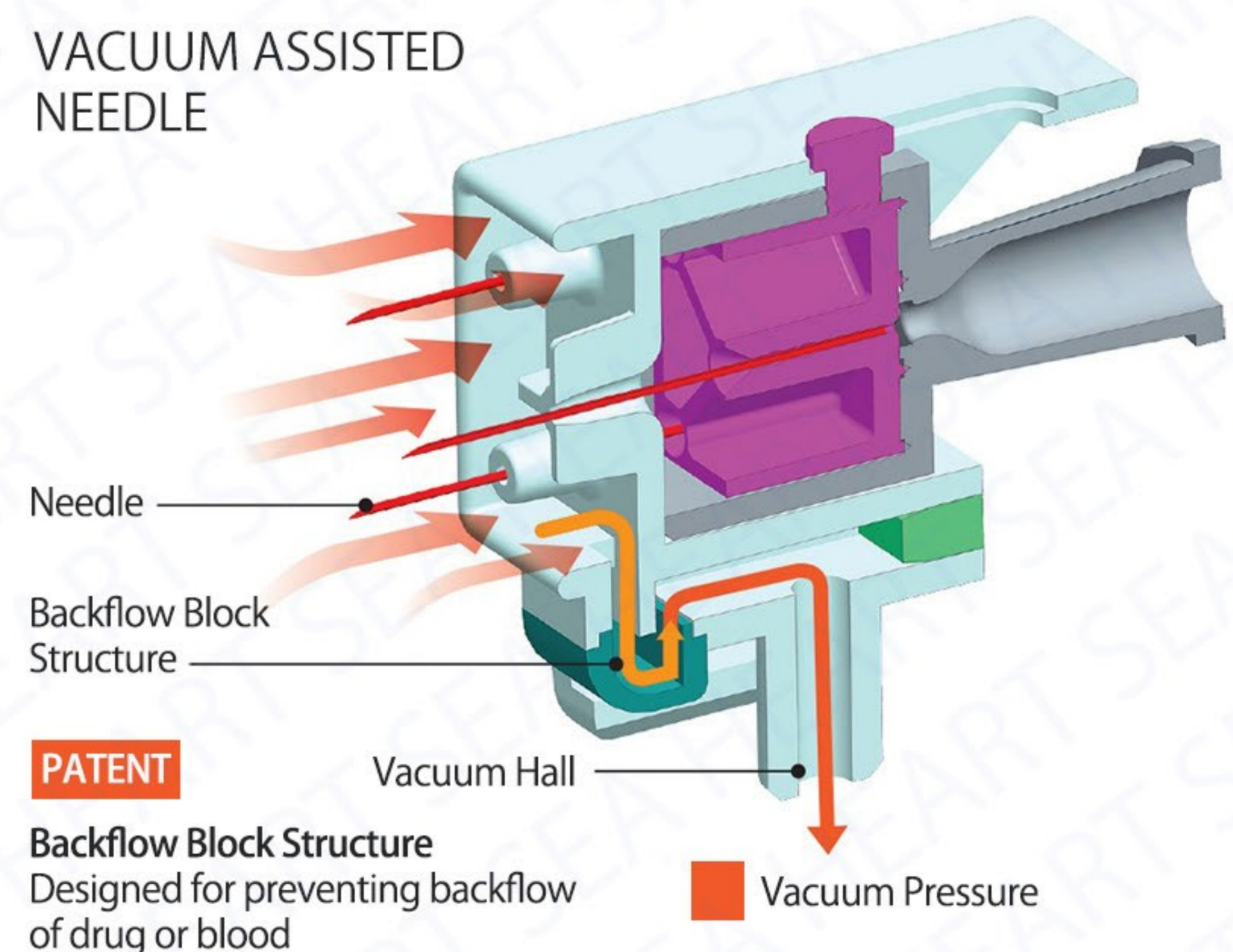

## Tender skin of below indications



Wrinkles, rough pores  
skin flabby prolapse



Freckles, spots, age spots  
chloasma, pigmentation pigmentary  
diseases, etc



Expansion of capillary, skin flush  
rosacea, vascular diseases such as  
lupus erythematosus acne



Skin dark heavy, low degree  
of finish, sebum secretion  
pimples

# VITAL INJECTOR II

Safer, Easier and Faster drug delivery system

- Hydration
- Elasticity
- Roughness
- Smoothness
- Complexion
- Texture

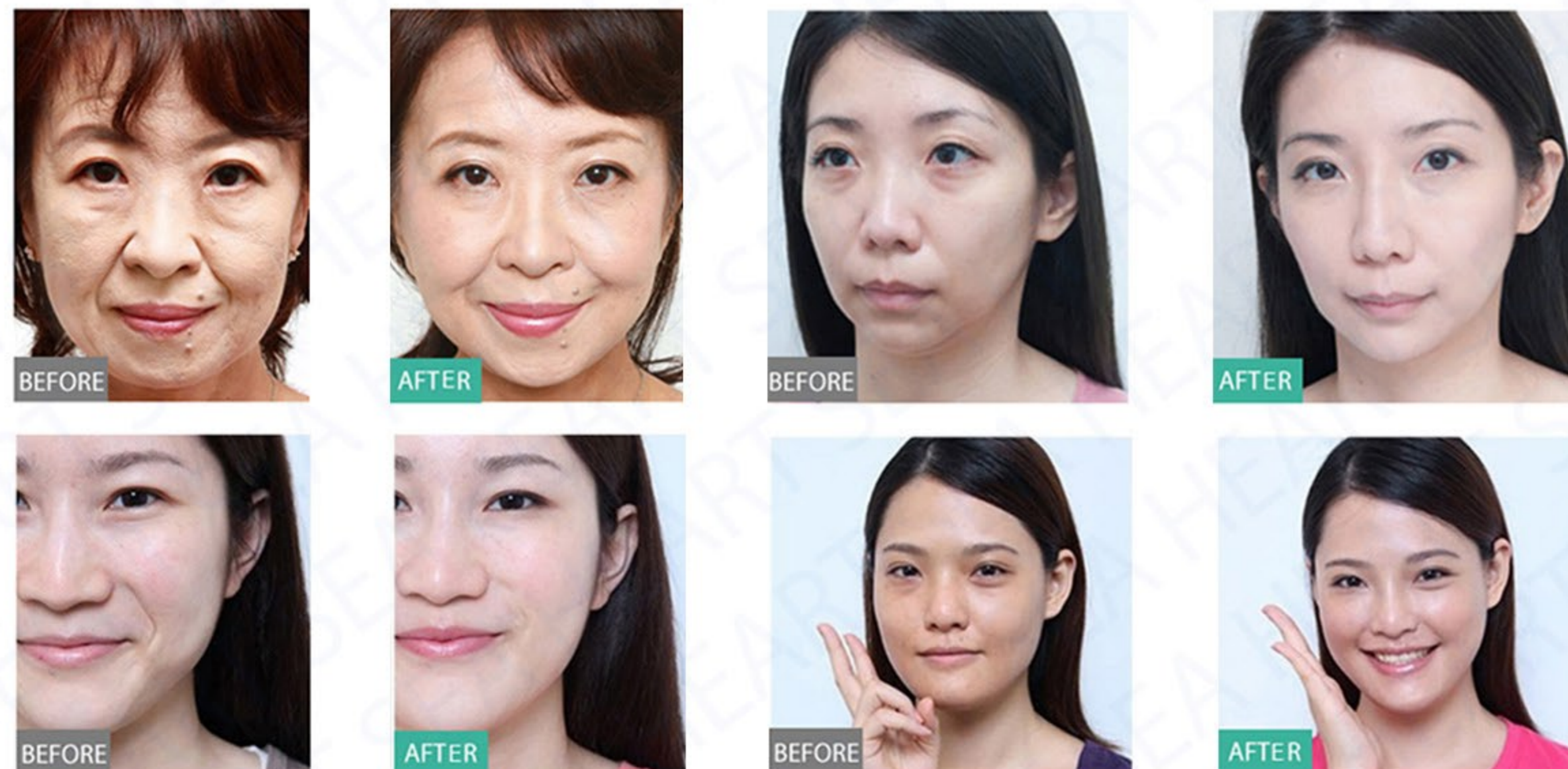
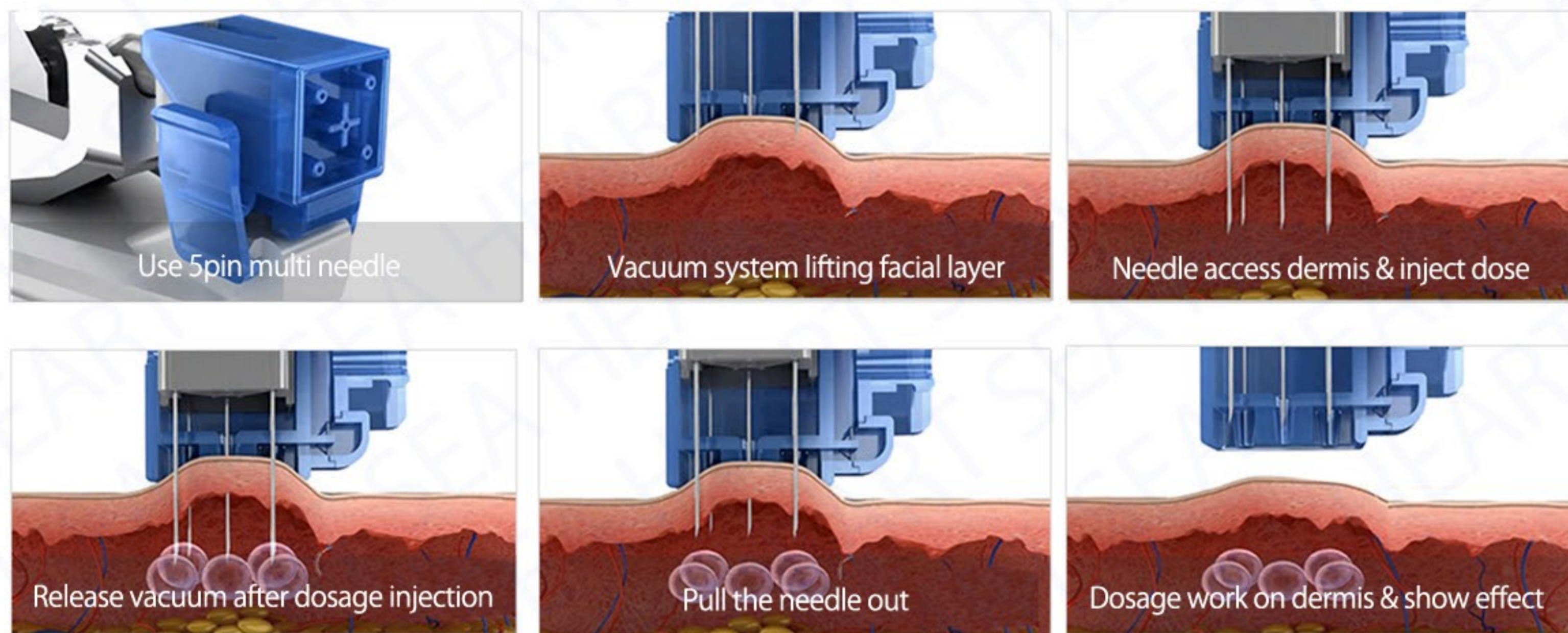

## VACUUM ASSISTED NEEDLE

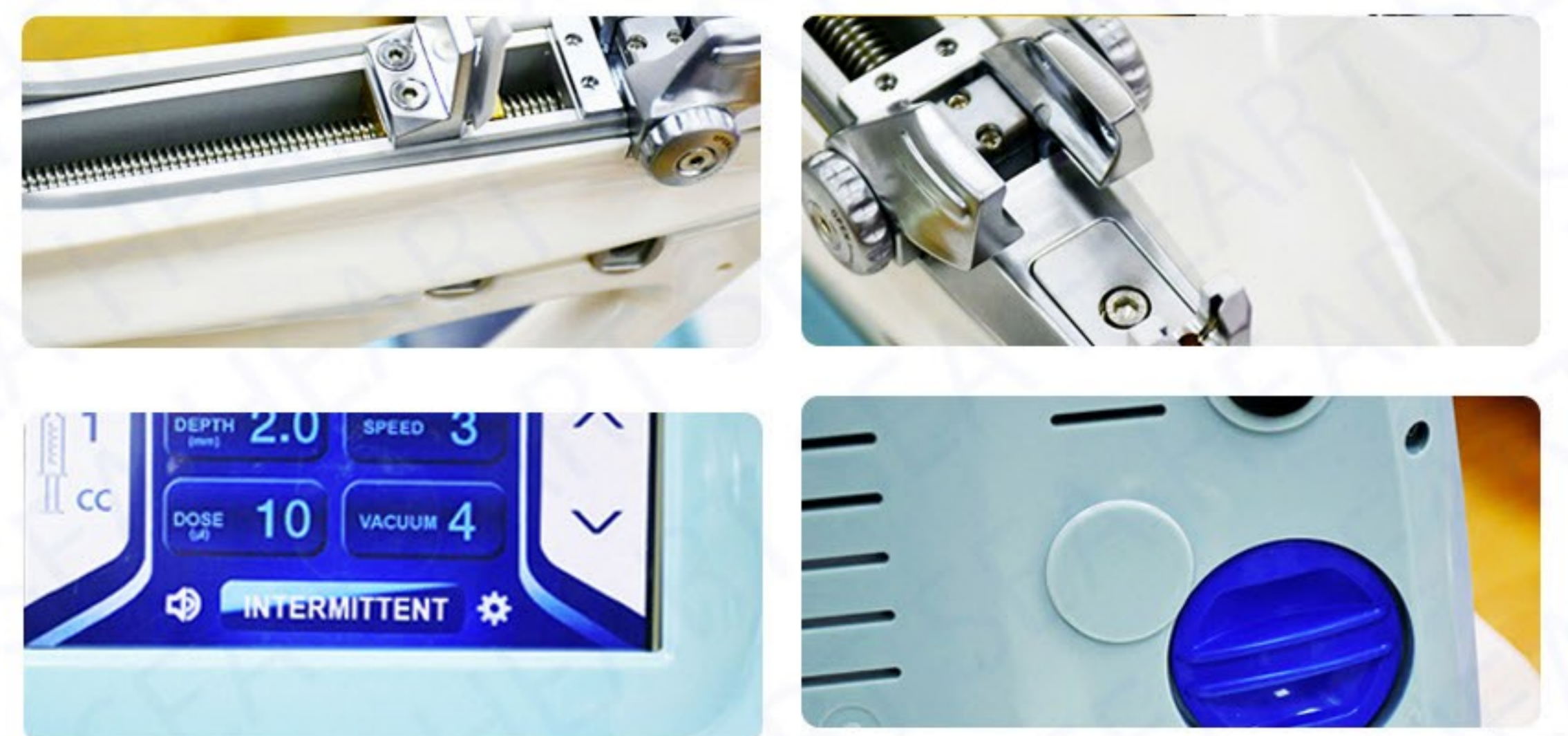
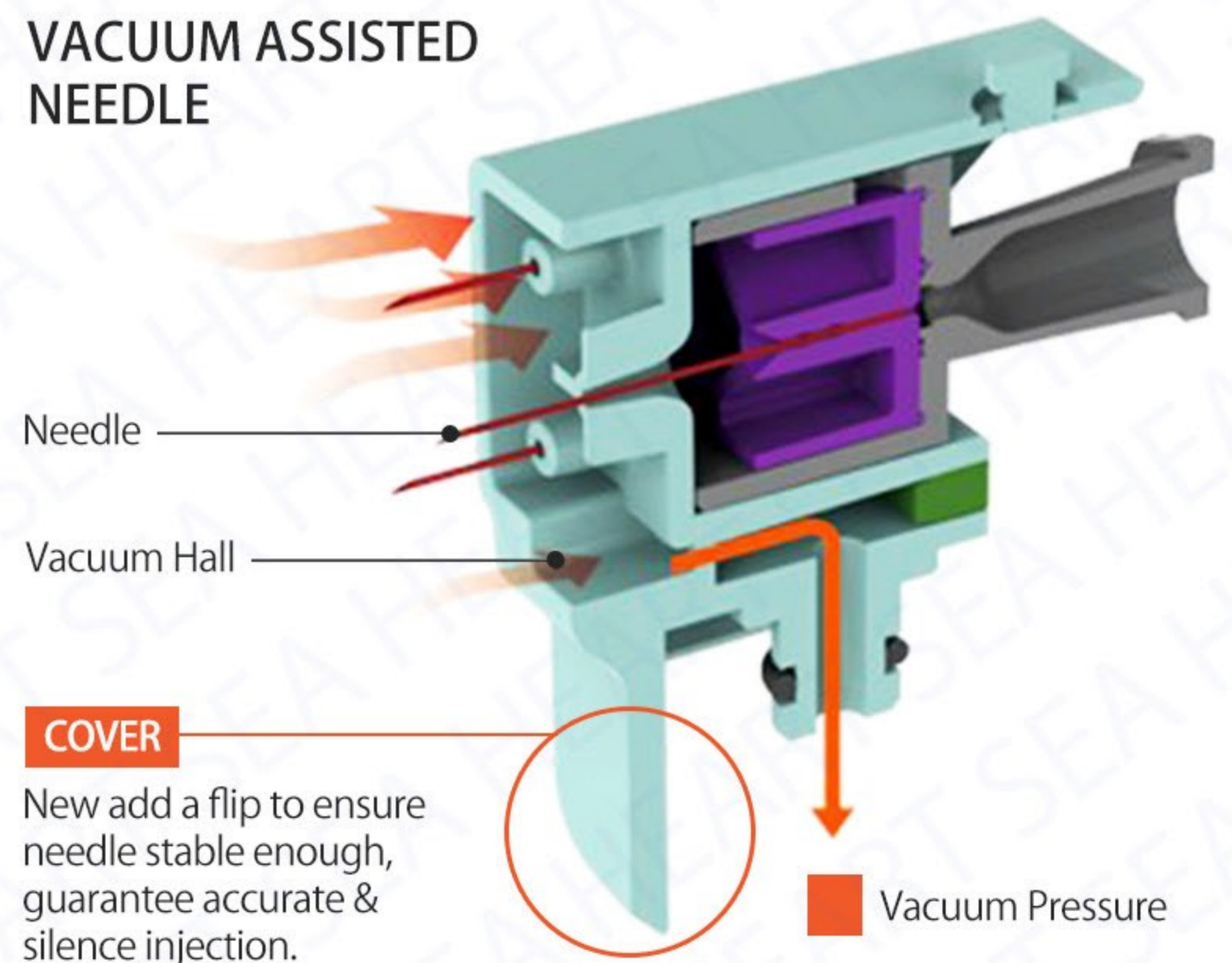

# MEDICAL AESTHETIC | BODY CARE | FACIAL CARE

## MESOTHERAPY INJECTION PRODUCT SPECIFICATIONS

Item					
Model	H1 / H1S	H2 / H2S	H5	H6	H8
Injection Type	Intermittent, Continuous	Intermittent, Continuous	Interval, Continuous	Auto, Sensing, Dose, Cont	Auto, Sensing, Dose, Cont
Injection Mode	Vaccum available	Vaccum available	Vaccum available	Vaccum available	Vaccum available
Needle	31G, 5/9Pin Multi-Needle	31G, 5/9Pin Multi-Needle	31G, 5/9Pin Multi-Needle	32G, 9Pin Multi-Needle	32G, 9Pin Multi-Needle
Depth	0.0 ~ 5.0mm	0.0 ~ 5.0mm	0.25 ~ 5.0mm	0.0 ~ 2.0mm	0.0 ~ 4.0mm
Syringe Type	1cc, 2cc, 3cc, 5cc	1cc, 2cc, 3cc, 5cc	1cc, 2cc, 3cc, 5cc	1cc, 2cc, 3cc, 5cc	1cc, 2cc, 3cc, 5cc
Packaging	58x26x44cm, 8Kg	44x46x33, 12Kg	45x42x33cm, 10Kg	47x40x45mm, 5.5kg	53x40x48mm, 15kg

Item					
Model	HD400	HD300S	HD300	H200	H100 / HD100D
Injection Mode	Continuous, Dose	Continuous	Continuous	Continuous, Dose	Continuous, Dose
Injection Type	Vaccum available	RF Non-Invasive	Non-Invasive	Vaccum available	Single Needle
Needle	31G, 5Pin Multi-Needle	6x6mm, 8x8mm, 15x13mm	Vanadium 25Pin	31G, 5Pin Multi-Needle	31G, 5Pin Multi-Needle
Depth / RF	1.5mm, 2.0mm, 2.5mm	1 ~ 4MHz	1.0 ~ 3.0mm	1.5mm, 2.0mm, 2.5mm	1.5mm, 2.0mm, 2.5mm
Syringe Type	1cc, 2cc, 3cc, 5cc	5cc	5cc	1cc, 2cc, 3cc, 5cc	5cc / 1cc, 5cc
Packaging	29x25x12cm, 1.5Kg	35x7x25cm, 1.4Kg	24x16x8cm, 650g	25x15x5cm, 1500g	8.5x7x3.5cm, 500g

Item					
Model	NV-H8	NV-H7	NV-H6		
Injection Mode	Continuous	Intermittent, Continuous	Continuous		
Injection Type	RF Non-Invasive	Jet Non-Invasive	Non-Invasive		
Needle / Pressure	3x3mm, 5.5x5.5mm, 8x8mm	5~10Kgf/cm2	Nanocrystals		
Depth / RF	2 ~ 4MHz	0.2 ~ 5.0mm	1.0 ~ 3.0mm		
Syringe Type	5cc	5cc	5cc		
Packaging	43x32x31cm, 5.5Kg	53x44x26cm, 18kg	43x35x14cm, 4.5Kg		

# Body Care System

MAKE YOUR LIFE BETTER, CHANGE YOUR BODY SHAPE

## 20 4 in 1 velashape - SM 7

VelaShape is a safe, comfortable, non-surgical procedure with no downtime.

## 22 Cryolipolysis fat freezing slimming system - ETG D4S

It offers the most advanced body slimming solution by the intergraded technology.

The system delivers cryo-energy during the treatment with vacuum & LED technologies which enhances the treatment effects.

## 23 2-in-1 Multi-polar RF & Vacuum slimming system - DC R30

R30 is a 2in1 system combining the stable multi polar frequency technique together with the vacuum function.

It is nonsurgical and designed for safe treatments with various sizes of the handpieces for treating different target area.

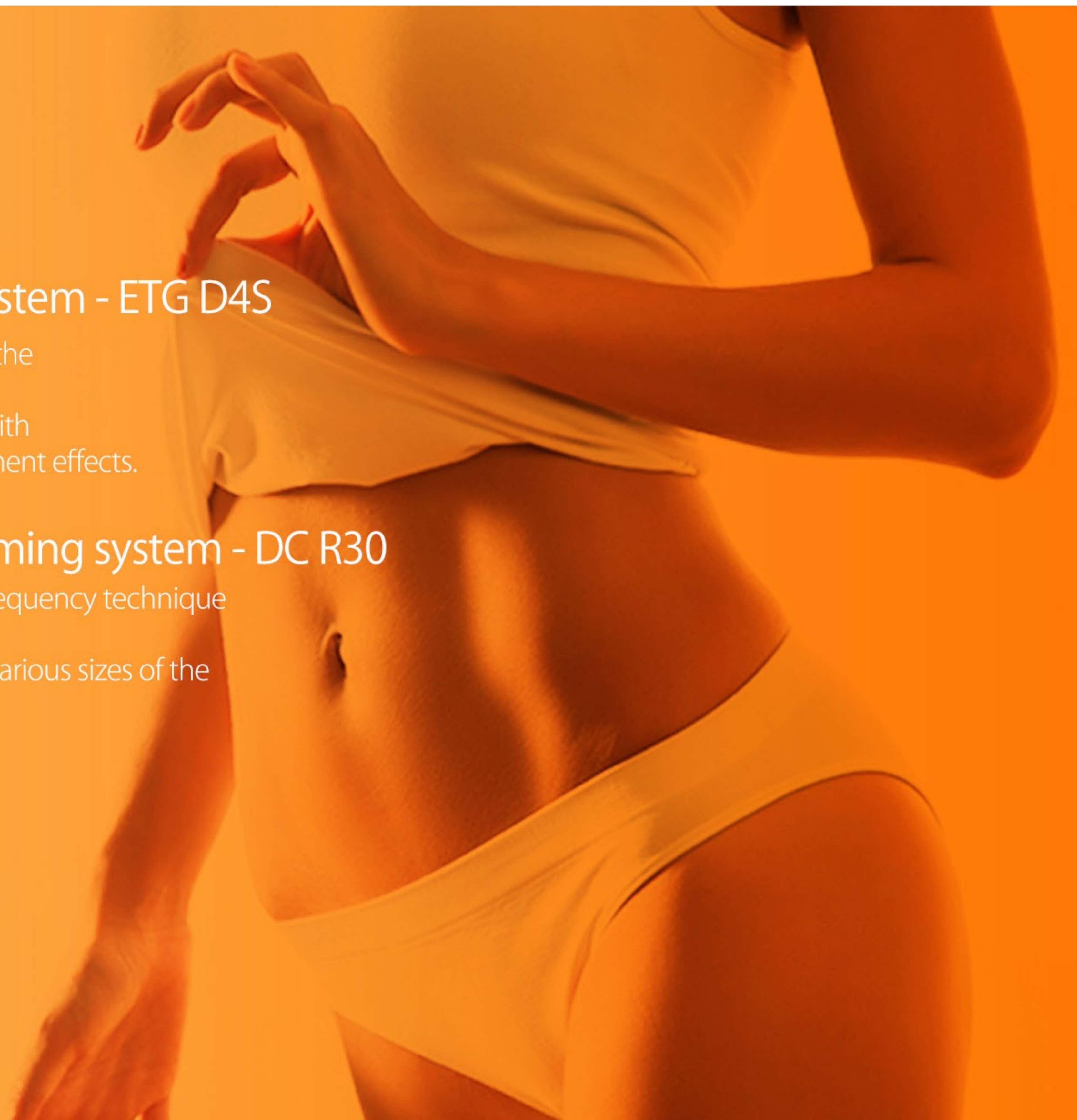



# 4 IN 1 VELASHAPE

VelaShape is a safe, comfortable, non-surgical procedure with no downtime.

- Massage
- Body shaping
- Cellulite reduction
- Skin tightening
- Wrinkle removal
- Skin surface smooth
- Eyelid area treatment
- Body slimming
- Body circumference
- Skin lifting

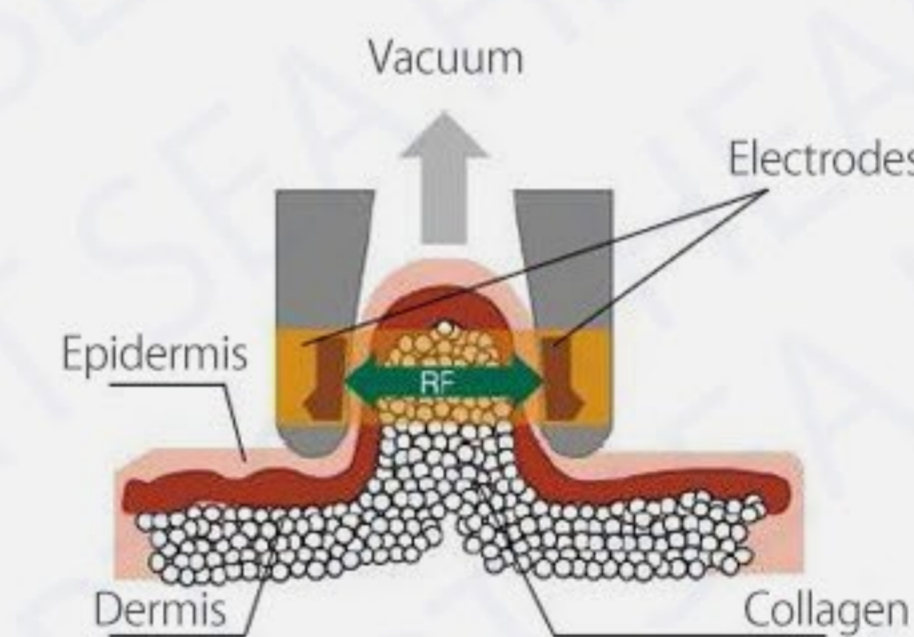
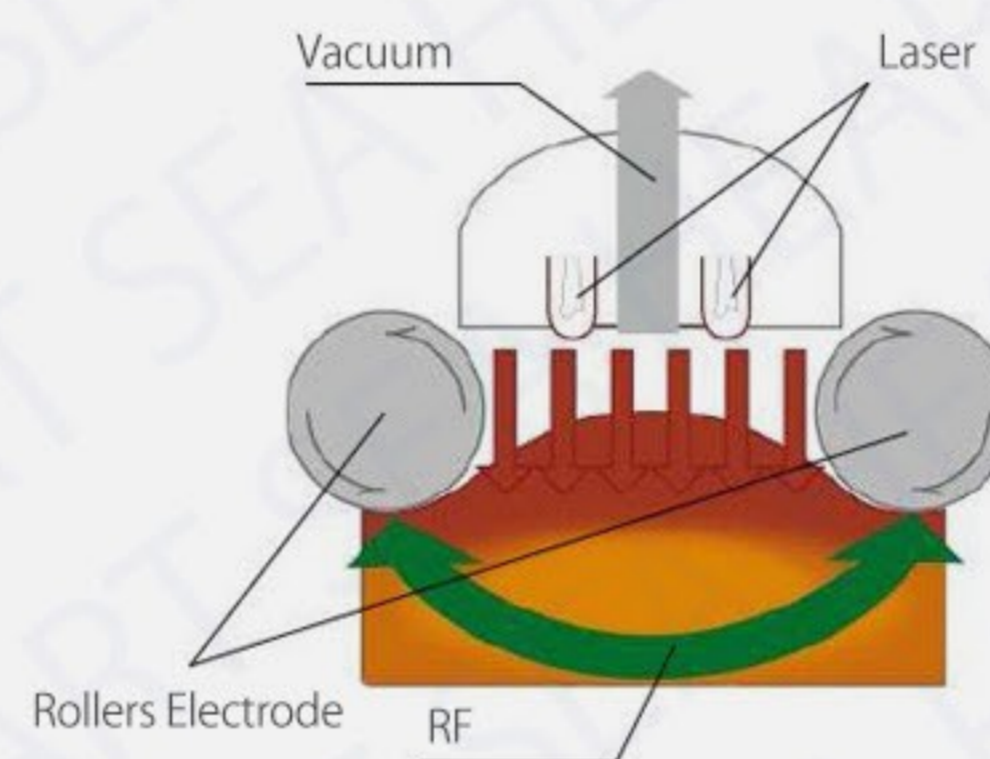

## ▪ How does it work?

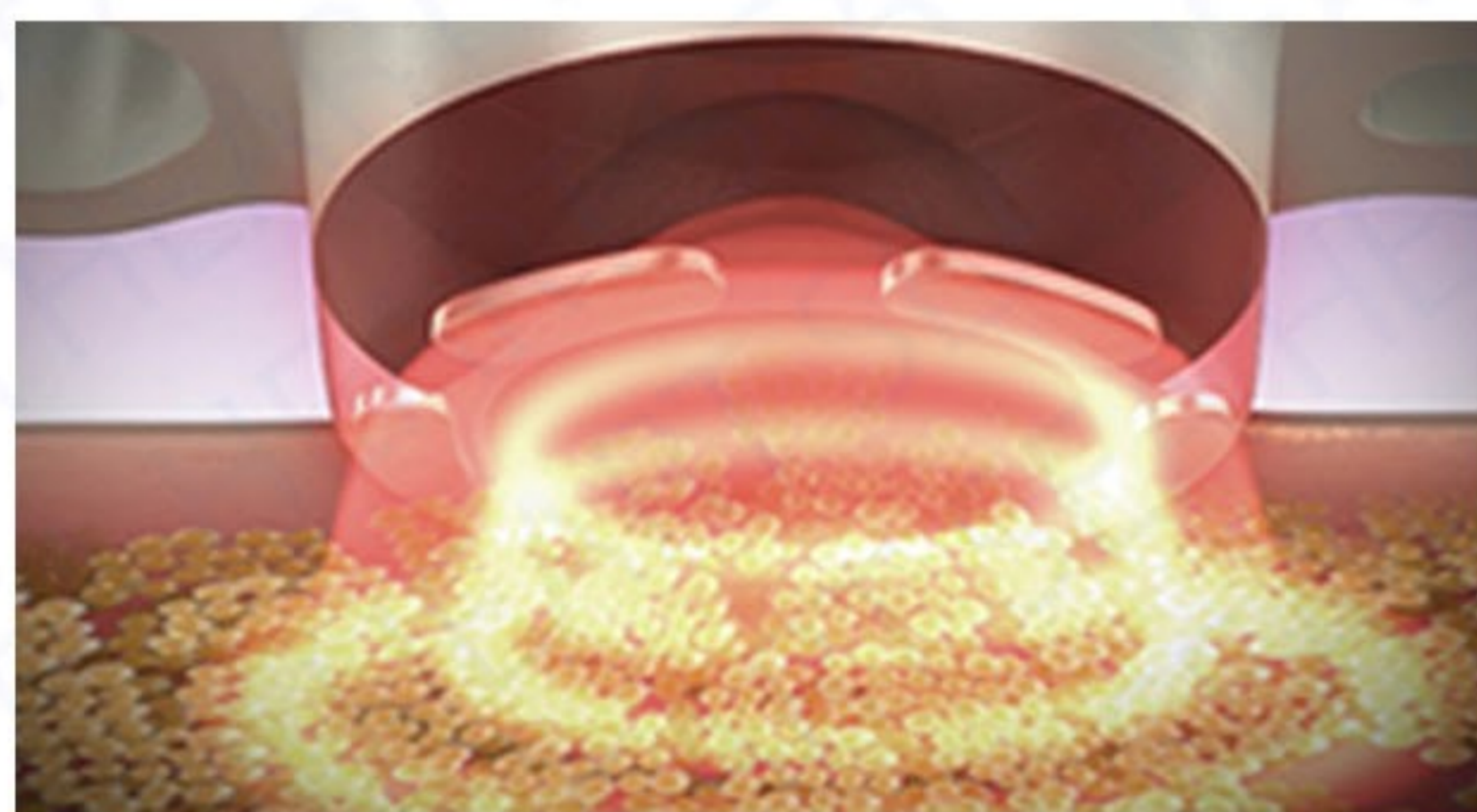

### Multi-Polar & Bi-Polar RF

RF delivers thermal energy deep into the dermal layer and boosts oxygen generation in the cells by heat and microcirculation. It reduces the size of fat cells to destabilize and then break down through the body's own natural process. It promotes metabolism and induces collagen regeneration. It helps skin tightening & firming.

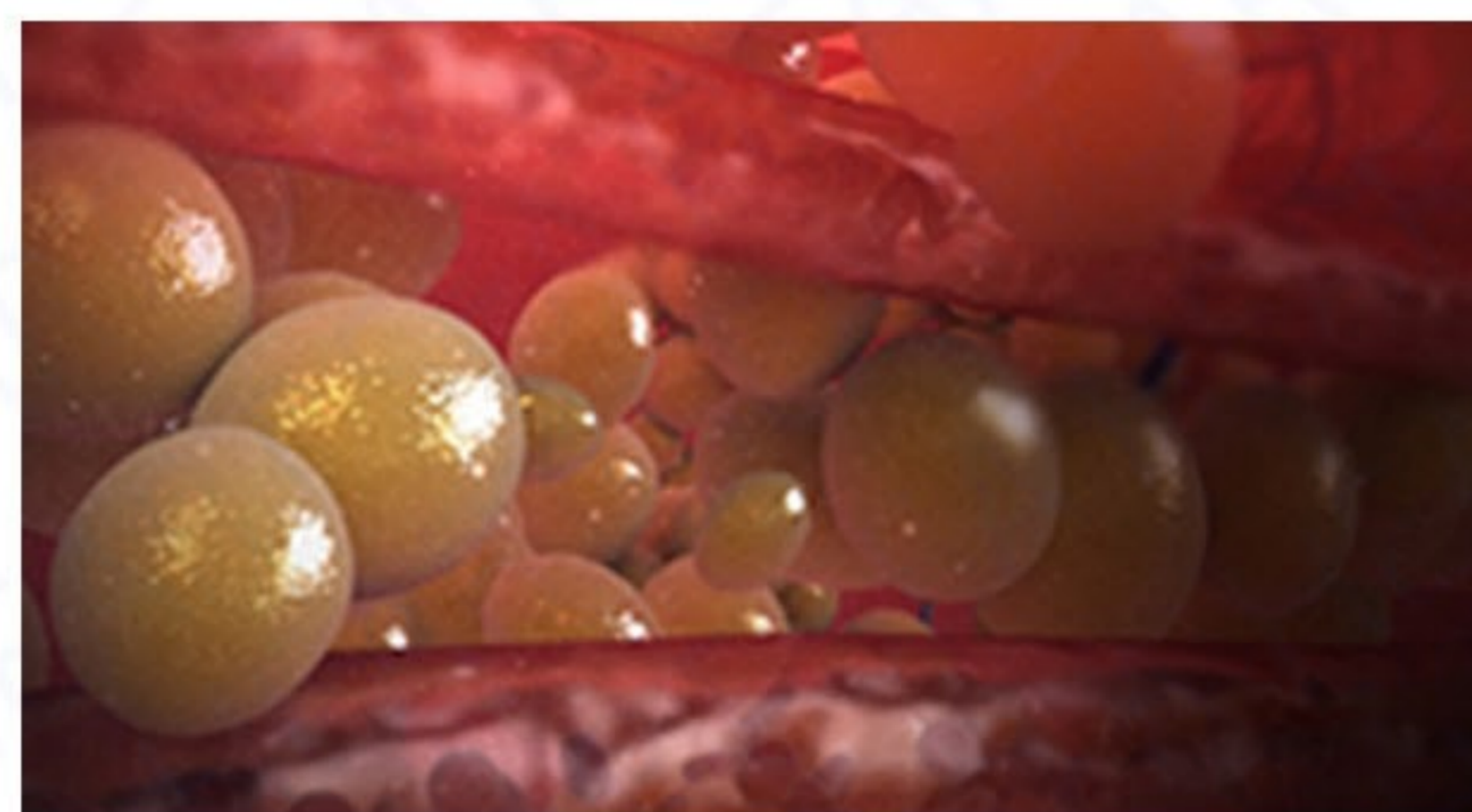

### Vacuum

The vacuum component increases the blood circulation and evens out the skin to optimize efficient energy delivery. The massaging effect from the vacuum induces lymphatic drainage and smooths out and reshapes the body. It provides oxygen into the cells and reduces the size of fat cells. It even alleviates of minor muscular pain and improves the body line.

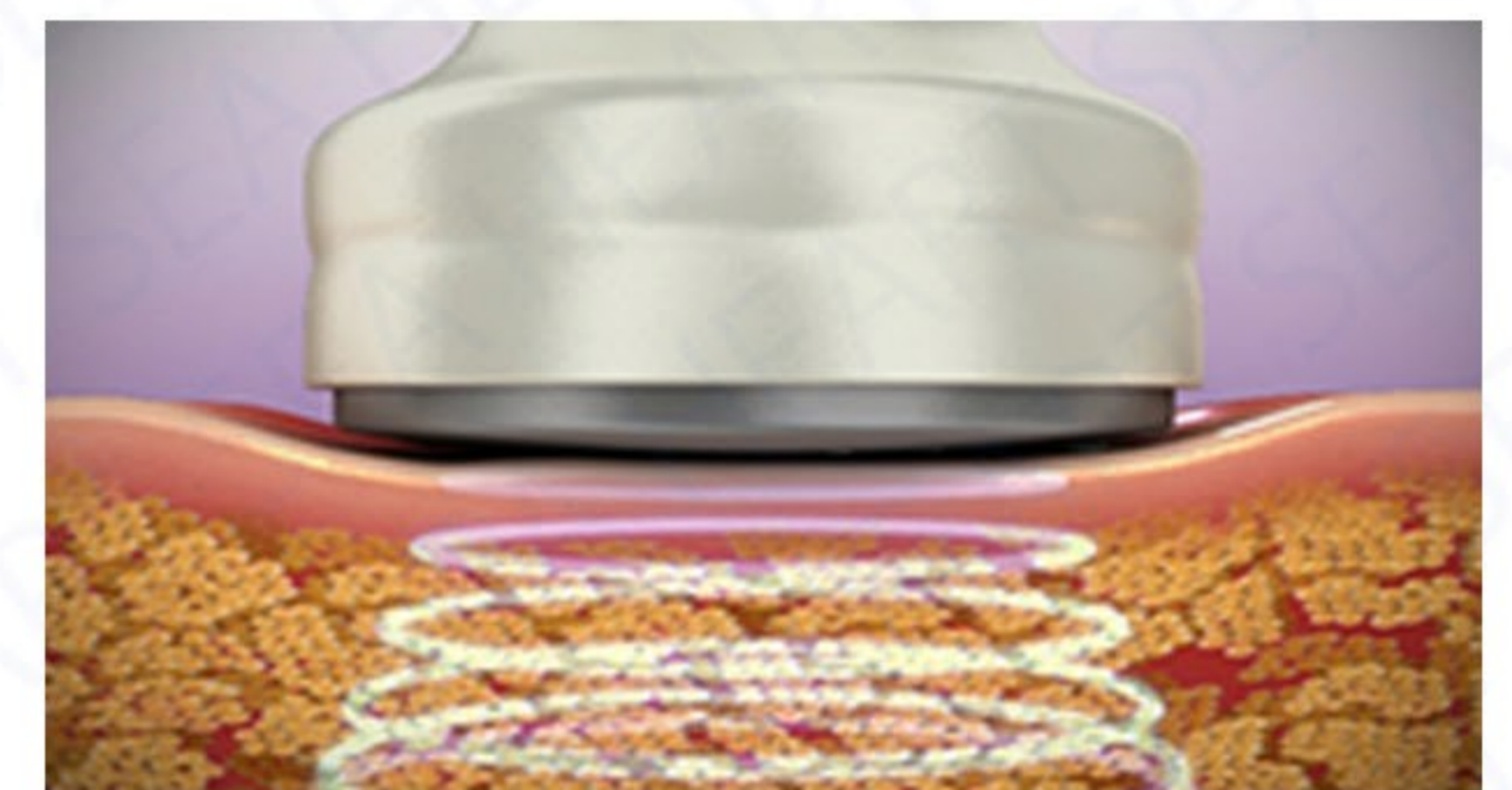

### Ultrasonic Cavitation

Ultrasonic Cavitation generates tiny bubbles and lets them grow and busted. 36KHz ultrasonic cavitation is for safe fat reduction. Its unique vibration technology increases frequencies and maximizes the effects of cavitation.

## Grade your own cellulite



### Cellulite Grade 1

Skin dimpling only during pinch test and compression.



### Cellulite Grade 2

Skin dimpling visible in some positions ( eg. standing )



### Cellulite Grade 3

Skin dimpling in all positions ( standing & lying down )

- *This machine combines Ultra-Cavitation, Stable Multi-Polar & Bi-Polar RF and Vacuum technologies. It is designed to boost body contouring and fat & cellulite reduction, The Bi-polar applicator is specially designed for eye & neck lifting. This multi purposed device can satisfy the patients' needs with dynamic and powerful vibration effects.*



### Mechanical roller massage

The positive rolling grasps and massages the skin tissue gently and continuously.



### Bipolar RF

Heats up the skin tissue for lifting and firming results.



### 940 nm infrared light

Warms up skin tissue fast to reach a great lipolysis result.



### Body Applicator

Works on the up-sucked fat tissue more safe and more effective.



### Cavitation Applicator

Powerful cavitation performance by dual generator Stable & Effective 36KHz frequency.

# CRYOLIPOLYSIS

Cooling lipolysis, Vacuum and LED to reduce fat cells and break down the fat.

**Vertical 4 Cryolipolysis Handles.**

Strong Cooling Maximum -10 °C.

Automatically control the cooling temperature.

Stable Vacuum Technology.

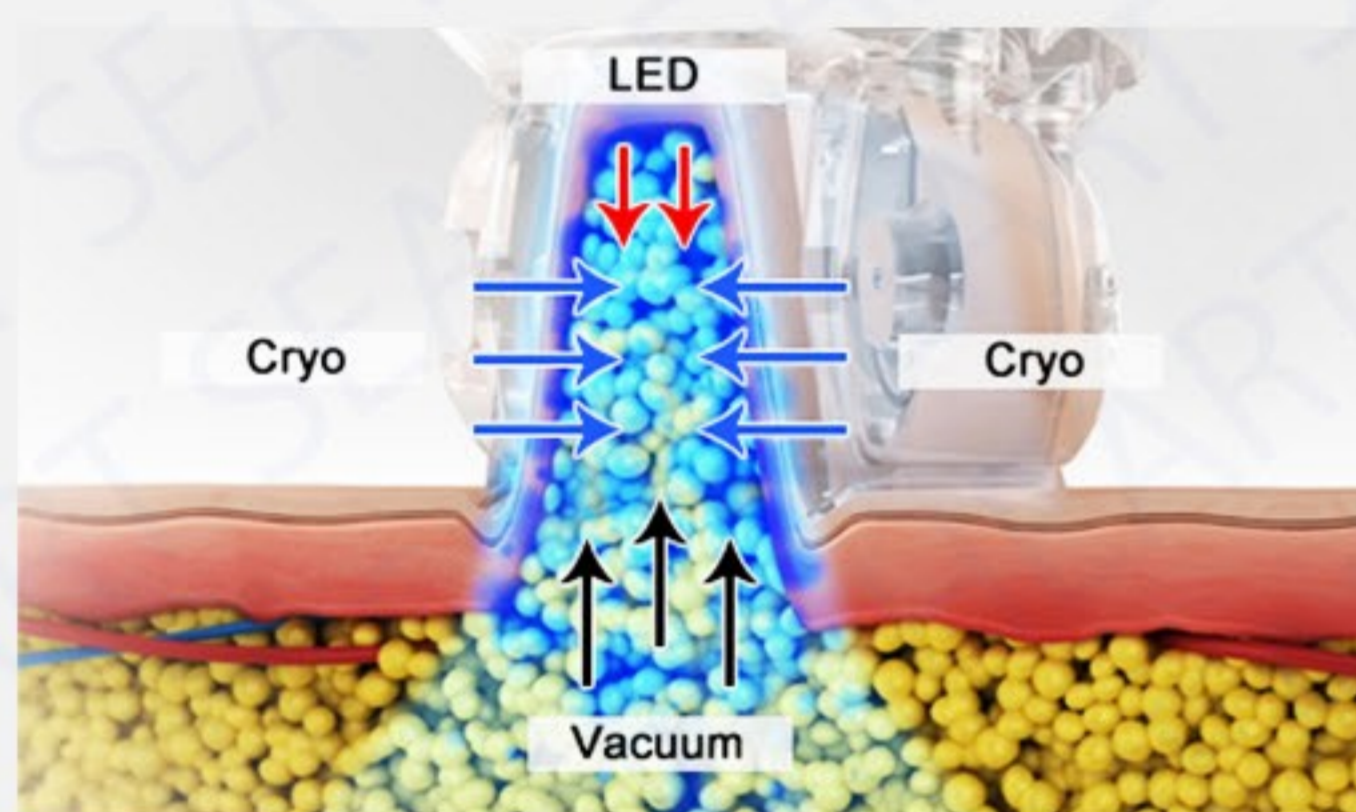

## How does it work?

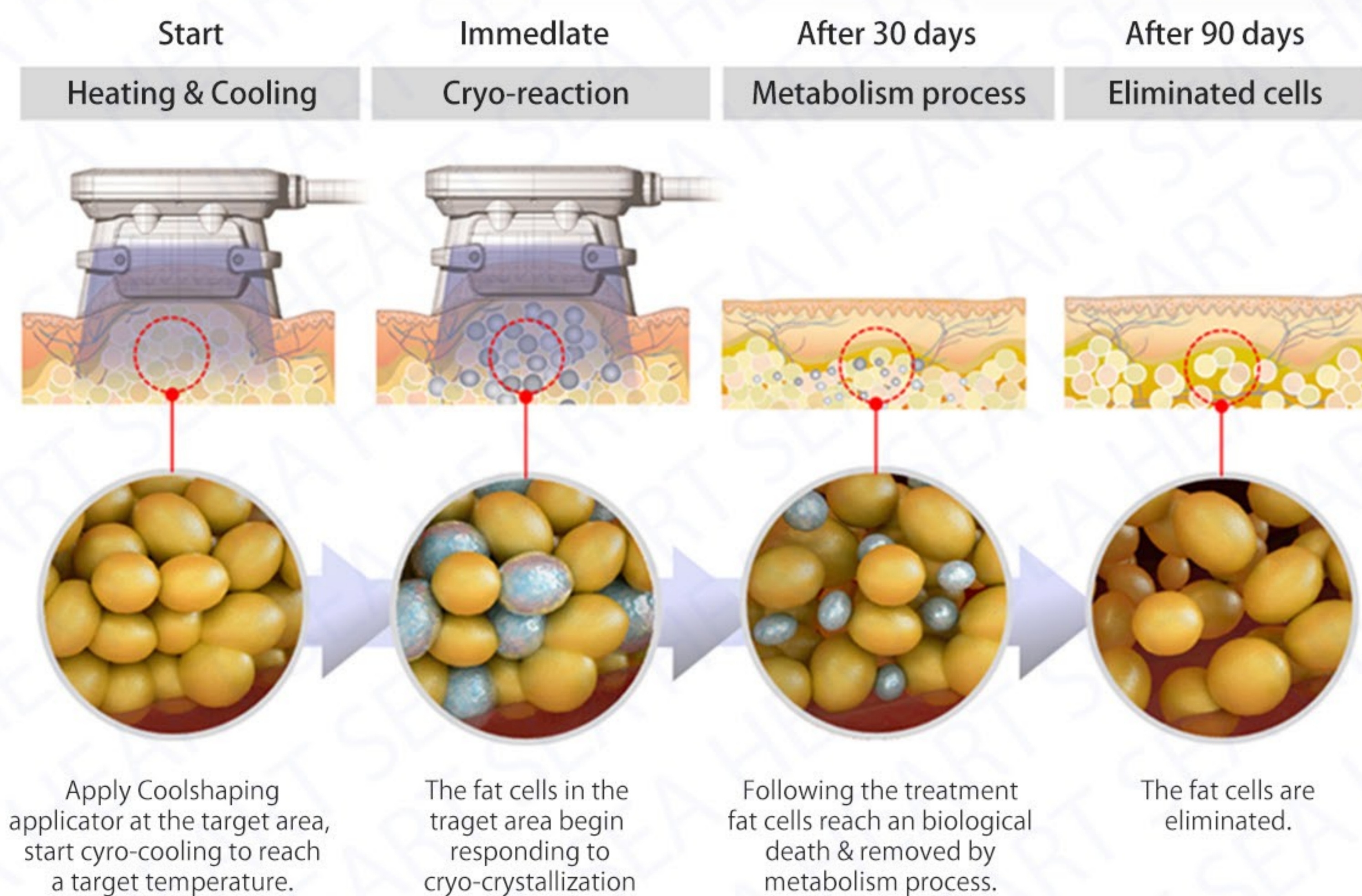

BEFORE

8 WEEKS AFTER

9 WEEKS AFTER

## Cryolipolysis handpiece



Size 200  
(190x70x92mm)

Size 150  
(130x50x65mm)

Size 100  
(90x43x65mm)

**FREEZE MINI**  
Applicator for Double Chin

Now cleared for  
**SUBMENTAL FAT**

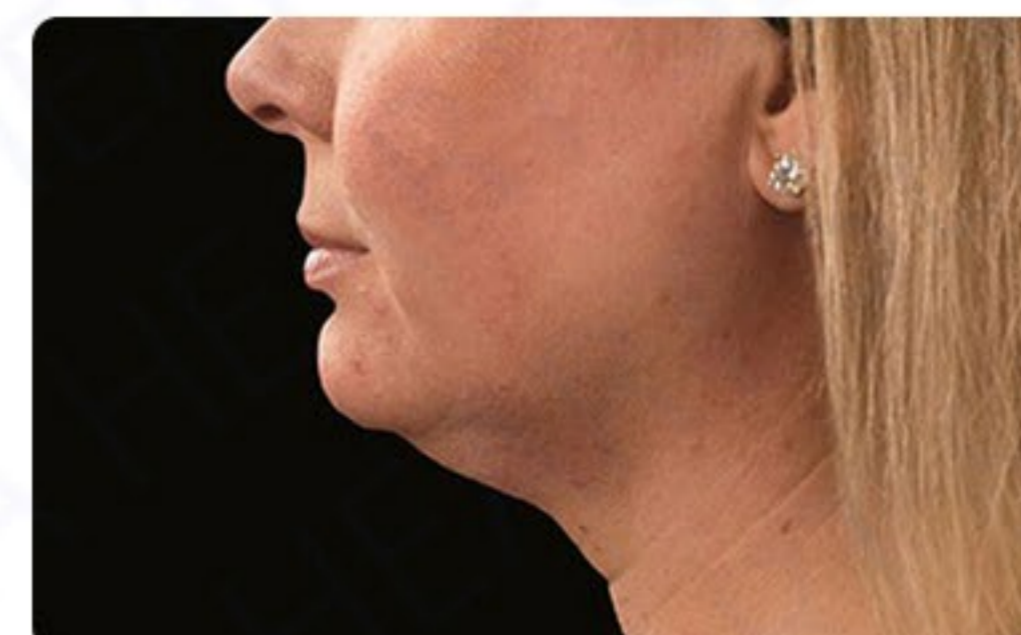
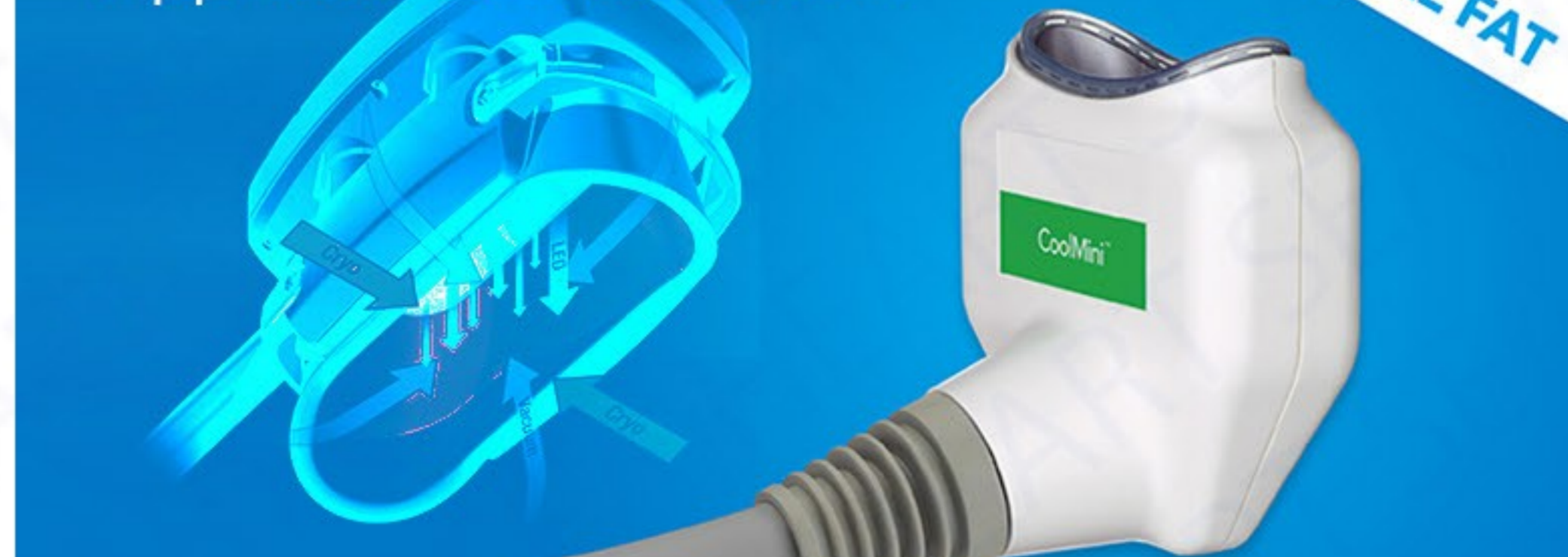

BEFORE



12 WEEKS AFTER



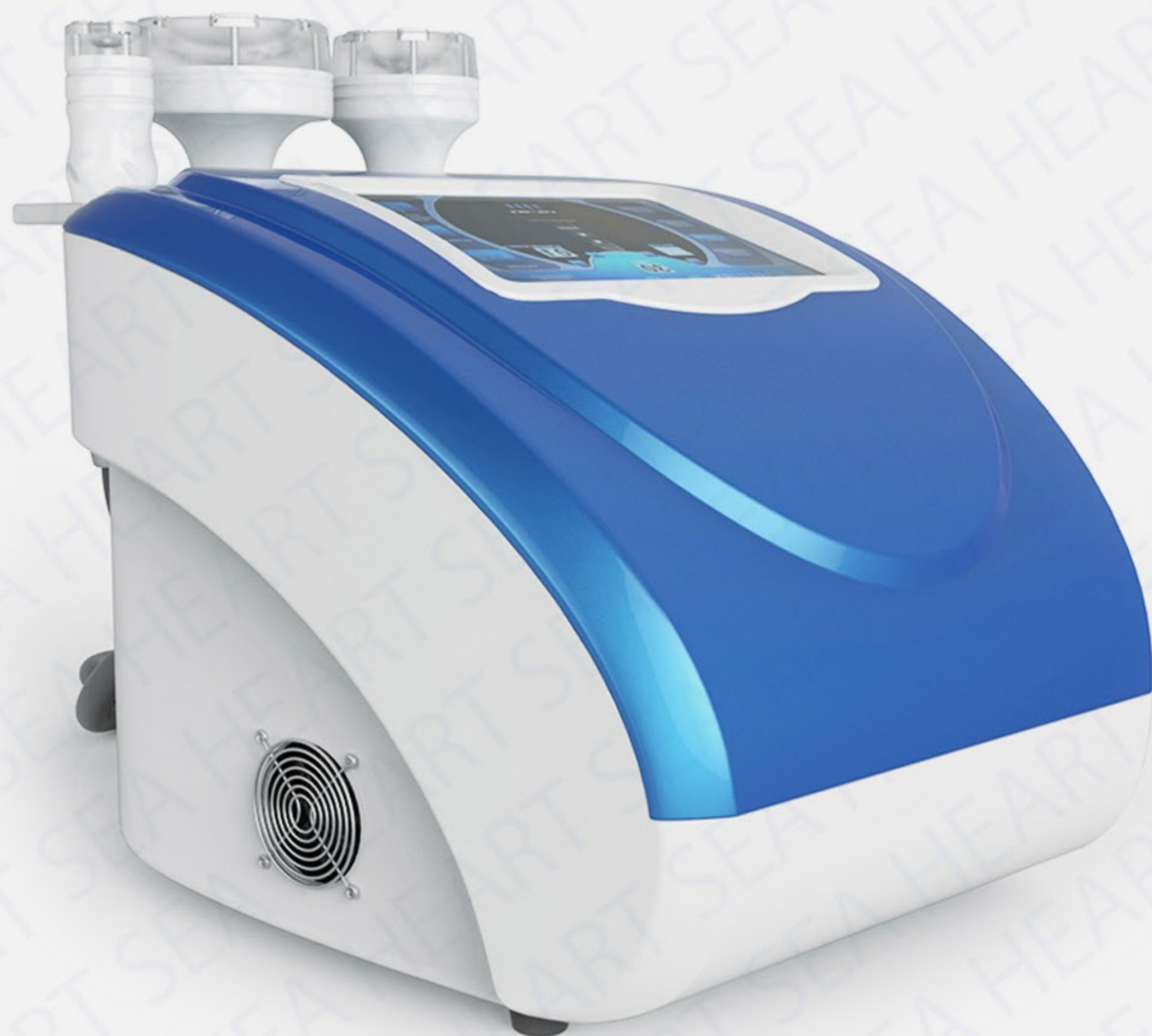

# FACE & BODY RF & VACUUM LIPOLYSIS SOLUTION

**3in1 ( RF+Vacuum+LED ) treatment for short time**  
 Non-surgical Body contouring and Face lifting  
 Efficient Cellulite & Fat reduction

- ✓ Easy control to operate
- ✓ User-Friendly Interface
- ✓ Easy carry compact design
- ✓ 4 types suction modes

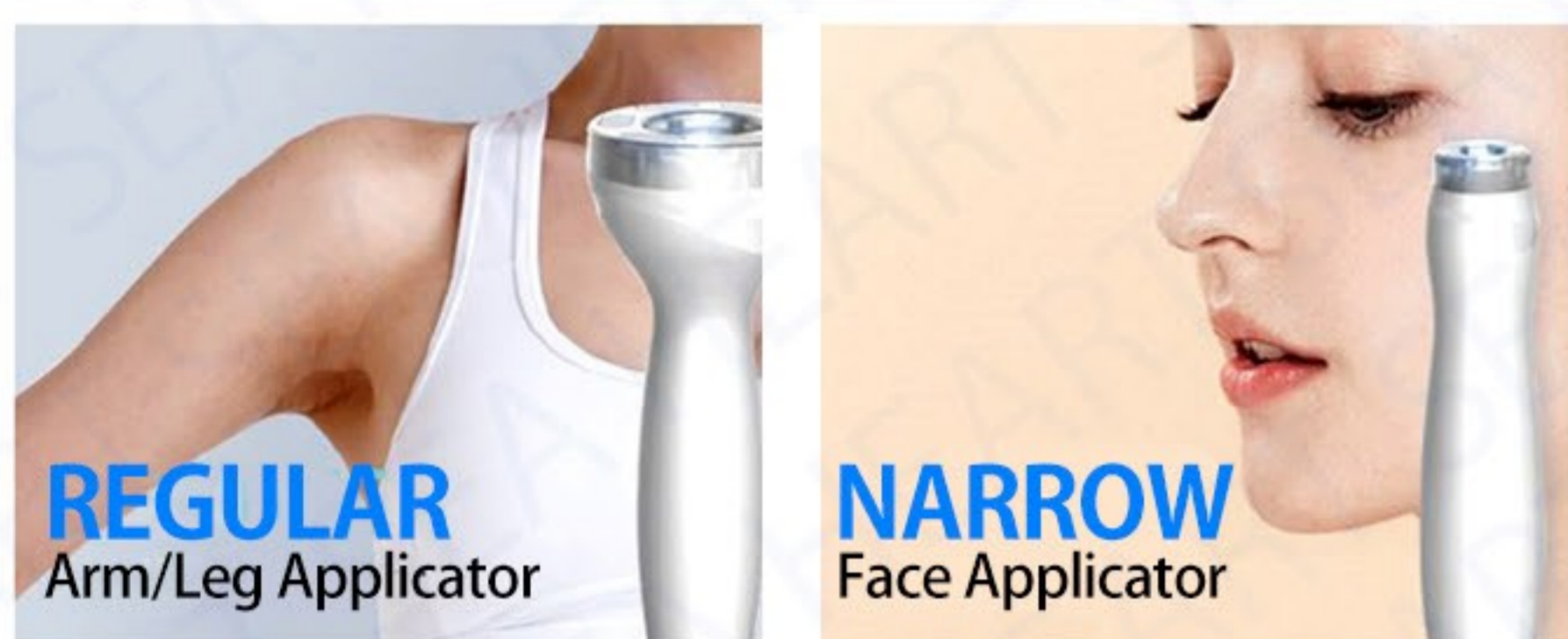
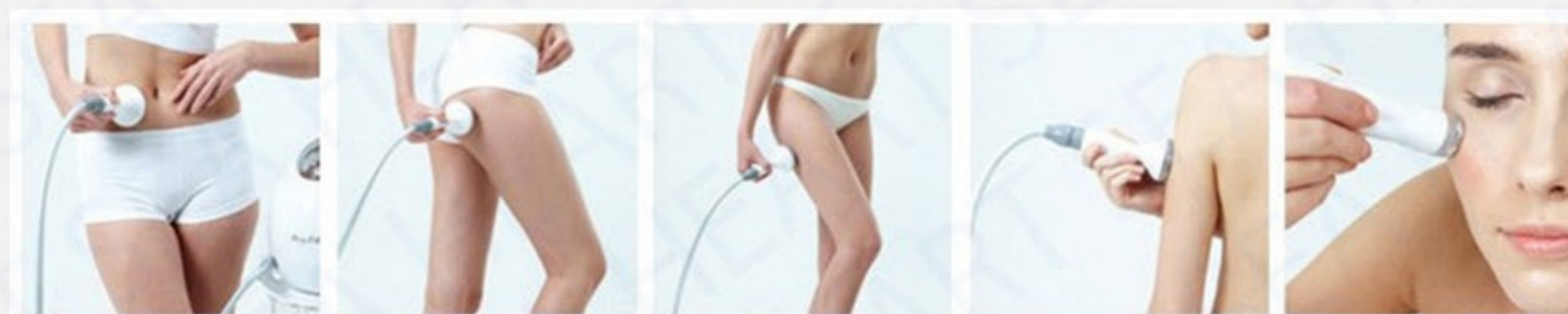

**Strong VACUUM**  
760mmHg



Sitmlulates skin, massage effect  
 Smoothen cellulite  
 Promote lymph drainage



**Deeply MultiPolar RF**  
0.8MHz



Delivers strong thermal effect in the skin ( Deep subcutaneous fat layer )  
 Treats cellulite and fat cells



**Powerful LED**  
610nm



Additional lipolysis effect using the most effective pulse for fat treatment



# MEDICAL AESTHETIC | BODY CARE | FACIAL CARE

Item			
Model	DC-R30	DC-R60	M93S
Type	Multipolar RF, LED & Vacuum	Ultrasonic & Multipolar RF	Fat Rotation, Ultrasonic & Multipolar RF
Vacuum	Max 760mmHg, 4 Mode Massage		Max 760mmHg
Ultrasonic		40KHz/1MHz	40KHz/1MHz
Radio Frequency	Multi-polar 0.8MHz	Multi-polar 5MHz	Multi-polar 5MHz
LED	Red 610nm / Blue 430nm		Red 630nm
Control	7 inch, Touch Screen	7 inch, Touch Screen	10.4 inch, Touch Screen
Packaging	58x58x33cm, 15Kg	46x49x31cm, 25Kg	44x93x110cm, 70Kg
Item			
Model	ETG-D4S	ETG50-4S	ETG50-5S
Power	500W	800W	800W
Infrared Light	37°C ~ 42°C	37°C ~ 42°C	37°C ~ 42°C
Cool-Shaping Temperature	5°C ~ -11°C	5°C ~ -11°C	5°C ~ -11°C
Vacuum	10 ~ 80Kpa	10 ~ 80Kpa	10 ~ 80Kpa
LED Light	Red & Green	Red & Green	Red & Green
Control	8 inch, Touch Screen	10 inch, Touch Screen	10 inch, Touch Screen
Packaging	43x45x64cm, 30Kg	63x54x125cm, 70Kg	63x54x125cm, 70Kg
Cryolipolysis Handle			
Size 100 ( 90x43x65mm )	x1	x1	
Size 150 ( 130x50x65mm )	x1	x1	x1
Size 200 ( 180x70x92mm )	x1	x1	x1
Size 300 ( 350x120x120mm )		x1	
Mini Handle ( 20x15x30mm )	x1		x2

# Facial Care System

MAKE YOUR LIFE BETTER, CHANGE YOUR SKIN TEXTURE

## 26 9-in-1 Hydr Dermabrasion System - SPA18

It provides all facial care including cleansing, solution penetration and lifting to a single device.

## 29 3-in-1 Special light Therapy System - Dr.Light

It is a LED light therapy device appropriate for normal skin to acne skin and atopic dermatitis using high performance LED light composed of three wavelengths.

## 30 Facial Imaging System - Magic.Mirror 4S

It is one of the advanced images analysis system in the world, using digital images technologies via RGB, UV and PL spectrum. It can diagnose lots of face's problems: like spot, pore, ultraviolet ray or sunshine etc.





# 9 IN 1 HYDRA DERMABRASION

Resurface. Refresh. Rehydrate.

**Detoxify. Rejuvenate. Clarify. Protect**

Clinically proven more effective than IPL  
for skin rejuvenation

Preferred treatment of Hollywood

- ✓ Fine Lines and Wrinkles
- ✓ Elasticity & Firmness
- ✓ Skin Tone Evenness & Vibrancy
- ✓ Skin Texture
- ✓ Skin Lift & Tighten
- ✓ Hyperpigmentation
- ✓ Oily/Congested Skin
- ✓ Enlarged Pores
- ✓ Advanced Signs of Aging
- ✓ Acne & Aging Skin

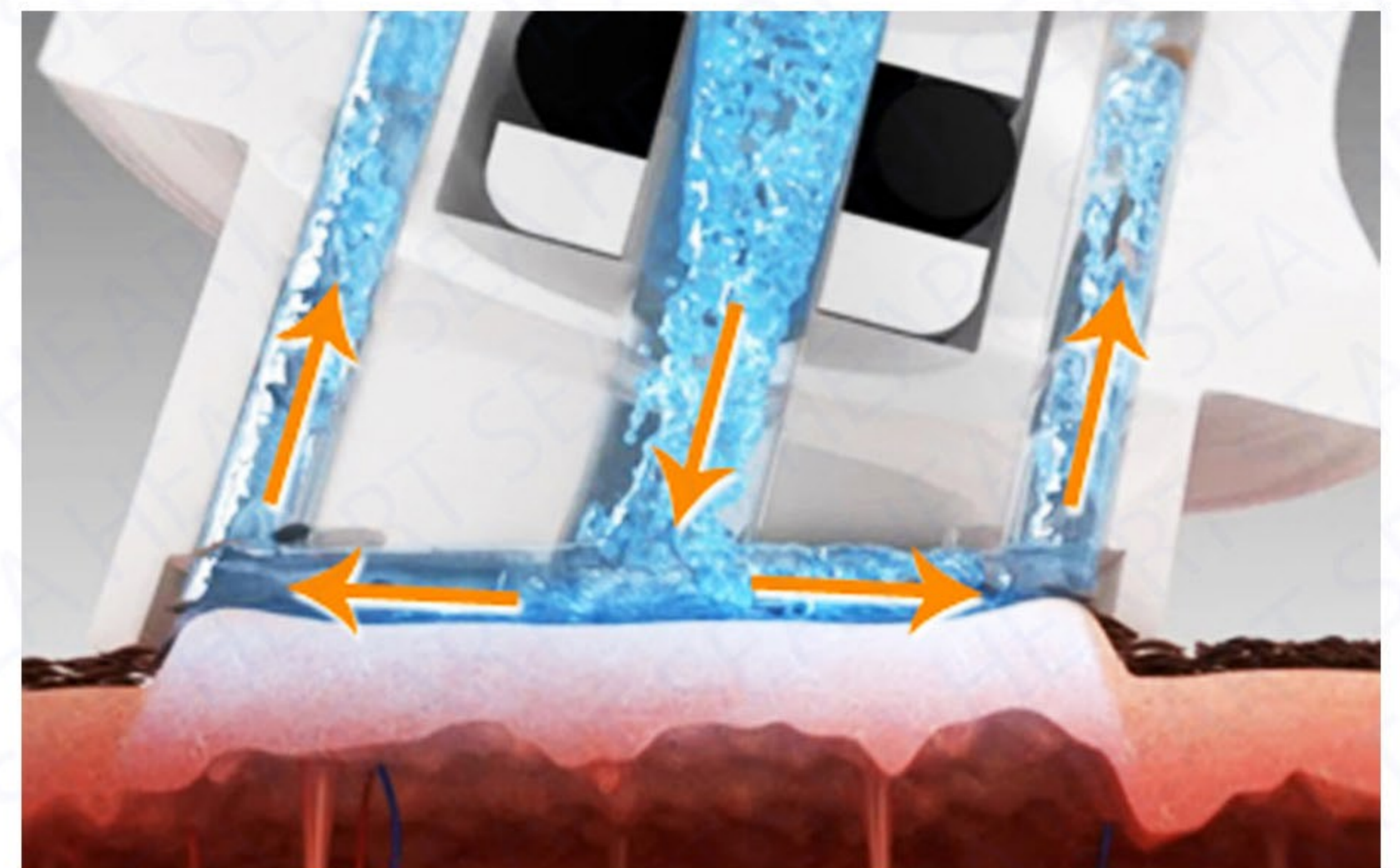

## STRONG AND SAFE Hydra Vacuum Technology

Maximum 750mmHg vacuum pressure with optimized vacuum pressure from 200mmHg to 760mmHg, safe and effective treatment for thin and sensitive skin to thick and dull skin are all possible with one system.



			
<p><b>STEP 1</b> <b>Non-irritating Cleansing</b></p> <p>Penetrates lactic Acid, a soluble solution (AHA), to dissolve bacteria sebum, cosmetic residue in the pores.</p>	<p><b>STEP 2</b> <b>T-Zone Intensive Care</b></p> <p>Applies salicylic acid, an oil controlling solution (BHA), to cleans the pore from sebum, black-head, T-zone, etc.</p>	<p><b>STEP 3</b> <b>Supplements Moisture &amp; Nourishments</b></p> <p>Permeates portulaca extract to provide vitamin B supplement, anti-oxidant effect, moisturize, melanin control &amp; supplement nourishing agents.</p>	<p><b>STEP 4</b> <b>Cleans &amp; Disinfect System</b></p> <p>Cleans and disinfect system after completing step 3.</p>
 <p>Before      After</p> <p>Back Acne After 2 Treatments</p>	 <p>Before      After</p> <p>Skin Hydration Significantly Increased After 1 Treatment</p>	 <p>Before      After</p> <p>Sun Damage Improved After 3 Treatments</p>	 <p>Before      After</p> <p>Facial Acne After 2 Treatments</p>

## TYPE OF HANDPIECE

 <p><b>Hydra Dermabrasion</b> Is excellent for all skin types. Provides immediate results. Keeps patients coming in monthly. Has no down time or irritation.</p>	 <p><b>Diamond peeling</b> Exfoliates dead skin and impurities. Improving skin elasticity of the cheeks, chin, neck, neckline, etc. Improving skin complexion.</p>	 <p><b>Microcurrent BIO</b> Improving skin elasticity of the Cheeks, Chin, Neck, Neckline, etc. Improving skin complexion.</p>
 <p><b>High Frequency</b> Applicable to stubborn acne, shrink enlarged pores, reduce wrinkles, fade dark eye circles, rejuvenate the condition of the scalp.</p>	 <p><b>Facial &amp; Eye Ultrasonic</b> Massage effect by the vibration. Wrinkle, Acne, Couperose, Scar face. 1MHz Ultrasound.</p>	 <p><b>Skin Scrubber</b> Deep fine wrinkle and make skin young and soft. Reduce melanin to get a whiten skin.</p>
 <p><b>Lymphatic Drainage</b> It can help with fine lines wrinkles, sinus problems and headaches. Improve tone &amp; skin colour reduce puffy skin &amp; swelling.</p>	 <p><b>LED Light</b> It's appropriate for normal skin to acne skin &amp; atopic dermatitis using high performance LED light.</p>	 <p><b>Oxygen Spray</b> Professional spray enhances the absorption of essential oil by oxygen spray and water complement.</p>

# MEDICAL AESTHETIC | BODY CARE | FACIAL CARE

Item					
Model	SPA100	SPA101	SPA102	SPA200	SPA201 / SPA202
Hydra Skin	x1 ( 8 tips )	x1 ( 8 tips )	x1 ( 8 tips )	x1 ( 8 tips )	x1 ( 8 tips )
Diamond Peeling	x1 ( 9 tips )	x1 ( 9 tips )	x1 ( 9 tips )	x1 ( 9 tips )	x1 ( 9 tips )
Jet Peeling					x1
BIO Microcurrent				Biopolar x1	
Vaccum / Pressure	550mmHg	760mmHg	760mmHg	760mmHg	760mmHg / 4.3Kgf/cm2
Control	Control Panel	Control Panel	4.3 inch, Touch Screen	4.3 inch, Touch Screen	Control Panel
Packaging	52x49x43cm, 4.5Kg	52x49x43cm, 16Kg	55x48x48cm, 18Kg	55x48x48cm, 18Kg	50x43x52cm, 15Kg

Item					
Model	SPA18	SPA600	SPA300 / SPA300S	SPA10 / SPA10E	SPA10S
Hydra Skin	x1 ( 8 tips )	x1 ( 8 tips )		x1 ( 8 tips )	x1 ( 8 tips )
Diamond Peeling	x1 ( 9 tips )	x1 ( 9 tips )		x1 ( 9 tips )	x1 ( 9 tips )
Jet Peeling			x1	x1	x1
Cooling & Heating					x1
Ultrasound	Facial x1, Eye x1			Facial x1, Eye x1	
High Frequency	x1 ( 4 tips )				
Lymphatic	x3				
BIO Microcurrent	Biopolar x1	Positive x1, Negative x1	Biopolar x1, Hexpolar x1	Biopolar x1	Biopolar x1, Hexpolar x1
Oxygen Injector		x1		x1	
Oxygen Sprayer	x1	x1		x1	
Skin Scrubber	x1	x1		x1	x1
PDT LED Light	x2 ( 630nm, 590nm, 520nm )	x1 ( 630nm, 590nm, 520nm )	x1 ( 630, 590, 415 & 830nm )	x1 ( 630nm, 590nm, 520nm )	
Vaccum / Pressure	760mmHg	760mmHg	8Kgf/cm2	760mmHg / 8Kgf/cm2	760mmHg / 8Kgf/cm2
Control	15 inch, Touch Screen	8 inch, Touch Screen	8 inch, Touch Screen	10.4 inch, Touch Screen	10.4 inch, Touch Screen
Packaging	60x52x132cm, 40Kg	65x50x115cm, 40Kg	68x50x130cm, 73Kg	125x60x60cm, 45Kg	135x70x65cm, 55Kg

# 3-IN-1 SPECIAL LIGHT THERAPY SYSTEM

- The three dimensional structure**  
 Three-dimensional structure can make LED light focusing to the inside and get the best treatment efficacy.
- Combination of LED beam**  
 Combinations of diverse beam can cure different skin troubles at the same time.



## ■ Component



### Red light (656nm)

Promote blood circulation, Skin cell regeneration, Pain relief, Functional improvement effect resilient.



### Blue light (415nm)

Soothing skin problems, acne bactericidal effect, sebum control.



### Infrared light (830nm)

Lightning effect and synergistic capabilities through the skin absorption of IR energy.

## ■ Usage Method

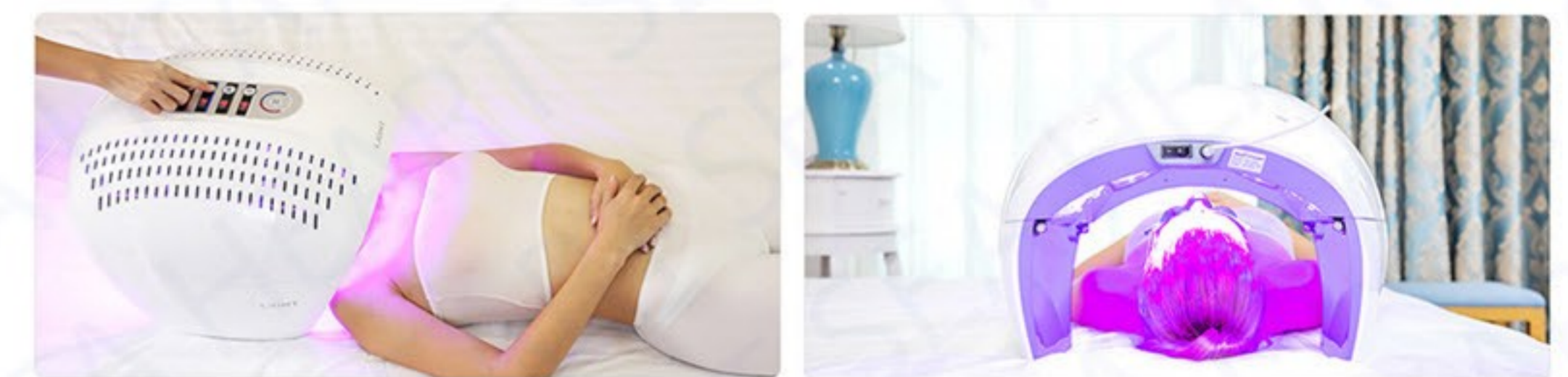

## ■ Specification

Type	LED light facial therapy system
Level	4 level
LED	Red 640nm, Blue 423nm, IR 830nm
Power	32W
Panel	Control panel
Packaging	48x50x35cm, 5Kg

# FACIAL IMAGING SYSTEM FOR CLINICAL RESEARCH

## RGB + PL + UV Spectrum

RGB Spectrum ( test moisture, pores and wrinkles )

Polarized Spectrum ( test roughness, spots and sensitivity )

UV Spectrum ( test acne, spots )

## Canon Camera

15 Megapixel which can precisely capture the details of the facial skin.

## X-Lens system

High quality RGB/UV/PL images



## ■ Clinical



Pigment Precipitation

Chemical Sunscreen

Reparative Factor

Vitiligo

Item					
Model	VIA	4S-15	4S-15P	2S-15	2S-12
Image Resolutions	21 Megapixel ( Canon 6D )	15 Megapixel ( Canon G10 )	15 Megapixel ( Canon G10 )	15 Megapixel	12 Megapixel
White Lighting ( RGB )	●	●	●	●	●
Polarized Light ( PL )	●	●	●	●	●
Ultraviolet ( UV )	●	●	●	●	●
Size ( H x W x D )	52 x 50 x 47cm	40 x 30 x 32cm	60 x 43 x 47cm	53 x 50 x 40cm	30 x 33 x 40cm
Weight	20Kg	7Kg	15Kg	12Kg	6Kg



# VISION STORY



## Good Innovation For Your Medical Aesthetic Needs

---

We are improving people's quality of life by providing a high quality med-aesthetic system by making significant contribution in areas such as health and beauty as an industry leader.

# About Us

**SEA HEART Group Limited** is a professional manufacturer of beauty products. We have been manufacturing products for some Top Medical Groups from Spain, Korea and Germany with the term of OEM since the year of 2003.

Our company has got independent import and export rights. Thus, we can distribute several kinds of product to clients globally. Some of our products have got European CE, RoHS, PSE, FDA, ISO9001:2001, ISO13485:2003 and other certifications.

We have been inspected onsite by TÜV SÜD, a third-party verification agency. They offer Assessment Reports and Verified Videos. This gives buyers trust and authoritative information about suppliers.



## Certification



# Factory

We have experienced R&D, after sales engineer team, to provide you with the perfect service.



# Patent





SEA HEART GROUP  
Technology for better healthcare

T. +86-10-87161306

T. +86 18601386524

Whats app:+86 18601386524

admin@seaheartbj.com

Wechat:seaheartbj

www.seaheartbj.com