

TIRRIT[®]
特力喷雾

Dispensing Solutions



TIRRIT[®]

余姚市特力喷雾器有限公司
YUYAO TIRRIT CO.,LTD

Address: CE14-15, Far East Industry Park, Yuyao, Zhejiang, China

Postcode: 315400

Tel: 86-574-62726692 62707404 62726694

Fax: 86-574-62705446

E-Mail: jjyuan@tirrit.net

[Http://www.tirrit.net](http://www.tirrit.net)

2020
CATALOGUE

YUYAO TIRRIT CO.,LTD

» 公司简介 Company Profile

余姚市特力喷雾器有限公司，专注于喷雾器及各类塑料制品研发与生产，产品主要包括手扣式喷雾头，手压式喷雾头，乳液泵，泡沫泵，真空泵，塑料盖及其它包装类等。产品广泛应用于个人护理，化妆品，生活家居，汽车清洁及食品等。并且90%的产品直接远销欧洲，美洲，亚洲等国家和地区。

本公司已率先通过了ISO9001，ISO14001及SA8000国际体系认证，拥有专业的产品研发部门，持续开发了很多新产品与新技术以满足不同客户的需求。我们的研发精神：“只要您说，其余的我们来做”，目前本公司正与世界顶级品牌合作。

本公司生产力量雄厚，拥有全自动装配生产线和系列测试设备。我们相信高品质的产品，具有竞争力的价格及科学的管理可以为客户开拓更广阔的市场。

YuYao Tirrit Co., Ltd., an ISO9001&ISO14001&SA8000 certified manufacturer of mechanical dispensing devices and spray pumps, serves the market of personal care products, cosmetics and fragrance, household and automotive, pharmaceutical and food.

With a wide product range, and a number of fully automatic assembly machines and testing devices, TIRRIT is well positioned to meet different market needs of trigger sprayers, finger sprayers, lotion pumps, foam pumps, airless pumps and other packaging components. Having our own product development center, we have gained constant energy to develop new products, explore new technology for marketplace and customer requests. Customers from Asia, USA & EU realize it is as simple as what they say to develop something special for them. TIRRIT is bringing more and more customer projects from global top brand clients.

Located in eastern China, TIRRIT not only brings out the best products, but also offers the most competitive prices. The most efficient management and the best labors assure our customers their good position in marketing, and the best solution for their projects.

TIRRIT is devoted to help you to succeed. Come to discuss with our exporters, you are always welcome!



Innovation For an Easier Life

» INDEX BY PRODUCTS

	MINI TRIGGER ----- PAGE 01-02 0.18CC/0.25CC/0.35CC/0.5CC
	MIST SPRAYER ----- PAGE 03-05 0.15CC-0.18CC ----- PAGE 03-04 0.5CC (NO METAL CONTACT) ----- PAGE 05
	1 INCH CRIMP MIST SPRAYER ----- PAGE 06 0.18CC 0.6CC (NO METAL CONTACT)
	PERFUME SPRAYER 0.15CC ----- PAGE 07-08 PERFUME SPRAYER 0.07CC (LOW PROFILE) --- PAGE 09-12
	POWDER PUMP ----- PAGE 13-14
	COSMETIC PUMP ----- PAGE 15-20 0.18CC ----- PAGE 15-18 0.25CC (NO METAL CONTACT) ----- PAGE 19 0.5CC (NO METAL CONTACT) ----- PAGE 20
	LOTION PUMP ----- PAGE 21-31 1.5CC LEFT-RIGHT LOCK ----- PAGE 21-22 2.0CC SCREW DOWN ----- PAGE 23-24 2.0CC-3.0CC NO METAL CONTACT PUMP ----- PAGE 25-27 2.5CC-3.5CC ----- PAGE 28-29 5.0CC-10.0CC NO METAL CONTACT PUMP ----- PAGE 30-31
	GALLON PUMP ----- PAGE 32-34 10-30CC
	FOAM PUMP ----- PAGE 35-36 0.35CC-0.75CC
	TRIGGER SPRAYER ----- PAGE 37-46
	XXS MINI PACK ----- PAGE 47-48
	DROPPER ----- PAGE 49
	CLOSURE & CAPS ----- PAGE 50-52

TIRRIT®

» Trigger Sprayer

ST1201 Mini Trigger

- This mini trigger with discharge rate 0.18cc per stroke delivers exceptional spray performance for lighter home and garden applications and personal care as well.
- An integrated lock between head and closure ensures that product is safe during shipping and storage.

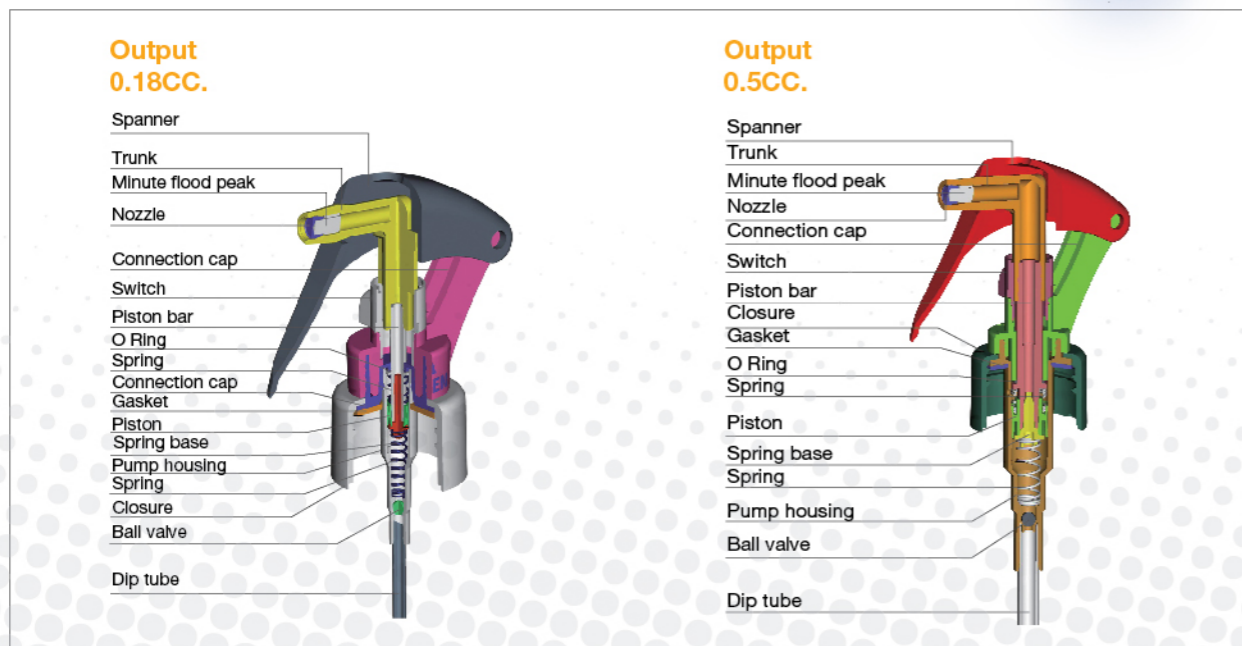

Output 0.18CC.



ST1201

ST1208

Upside down

Output 0.25CC.



ST1204

ST1205

Output 0.35-0.5CC.



ST1203

ST1206

ST1207 0.35CC

Closure.



24/410
Ribbed & smooth

24/415
Ribbed & smooth

28/410
Ribbed & smooth

28 BPF

Item	Output	Qty/CTN(pcs)	Meas.(cm)
ST1201	0.18CC	1000	57x37x45
ST1203	0.5CC	1000	57x37x45
ST1204	0.25CC	1000	57x37x45
ST1205	0.25CC	1000	57x37x45
ST1206	0.5CC	1000	57x37x45
ST1208	0.18CC	1000	57x37x45
Upside down	0.165CC	1000	57x37x45

TIRRIT®

» ST3002 Mist Sprayer

Compatibility

Compatibility testing is recommended if there are questions or concerns. TIRRIT offers complete laboratory testing assistance and provides recommendations to assist customers with their final packaging decision.

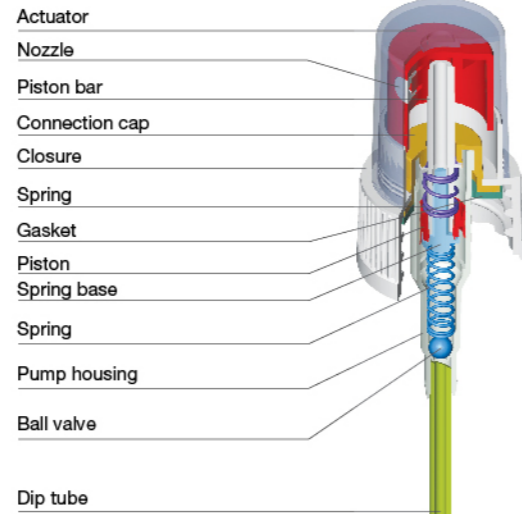

» ST3002 Series

ST3002



Item	Output	Qty/CTN(pcs)	Meas.(cm)
ST3002 (16/410-18/415)	0.15CC	2500	45.5x38x44
ST3002 (20/410-28/410)	0.18CC	2500	45.5x38x44
ST3002U Upside down sprayer	0.16CC	2500	45.5x38x44
ST3002I Oil sprayer	0.15CC	2500	45.5x38x44



16/410 18/400 18/410 18/415 20/410 Smooth 20/410



20/415 22/410H 22/415 24/410 Smooth 24/410 24GS



24/415 Smooth 24/415 28/410H ST3002U Upside down sprayer ST3002I Oil sprayer 20/400 Smooth



22/400 Ribbed

Others.



Metal Collar for options

Metal over cap (for 18/400 18/410 18/415)

TIRRIT®

» ST3210 0.5CC Mist Sprayer

(No Metal Contact)

TIRRIT®

» 1 Inch Crimp Mist Sprayer

» ST3210 0.5CC

Output
0.5CC.



ST3210
24/410

ST3210
28/410

Output.



0.5CC

Compatibility

Compatibility testing is recommended if there are questions or concerns. TIRRIT offers complete laboratory testing assistance and provides recommendations to assist customers with their final packaging decision.

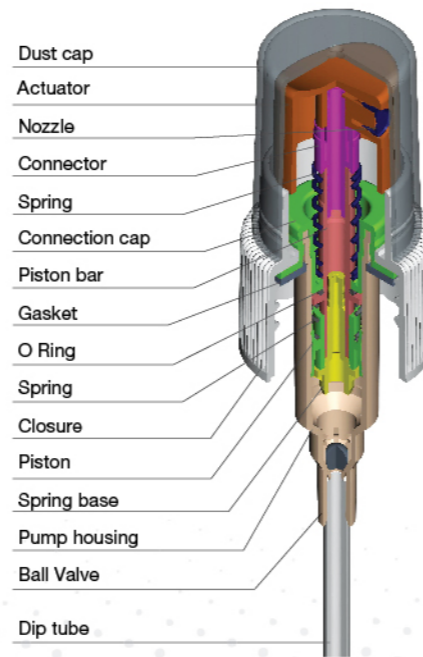

» ST3035 Series

Output
0.18CC.



ST3035



ST3036

Output
0.6CC.



ST3037 No metal contact

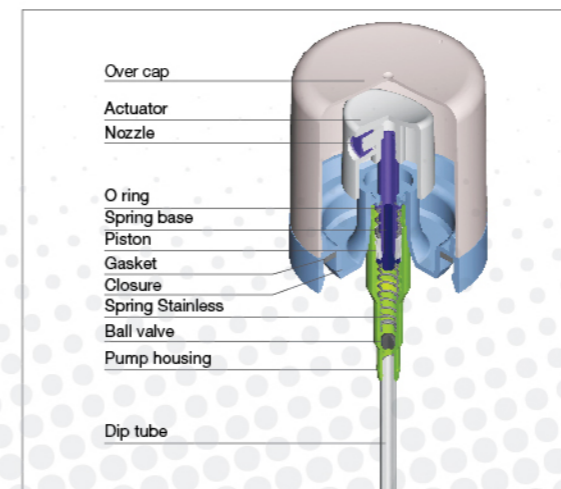

Output.



0.18CC



0.6CC

Item	Output	Qty/CTN(pcs)	Meas.(cm)
ST3210	0.5CC	2500	45.5x38x44

Item	Output	Qty/CTN(pcs)	Meas.(cm)
ST3035	0.18CC	2500	45.5x38x44
ST3036	0.18CC	2500	45.5x38x44
ST3037	0.6CC	2500	45.5x38x44

TIRRIT®

» Perfume Sprayer

ST3010 0.15CC

- Our crimping mist sprayer is available in range of $\Phi 15, 18, 20$ mm closure dimensions, normal and low profile and 0.15cc & 0.1cc output for options.
- To avoid carelessly depression of the actuator, we offer plastic safety clip of options.

Compatibility

Compatibility testing is recommended if there are questions or concerns. TIRRIT offers complete laboratory testing assistance and provides recommendations to assist customers with their final packaging decision.

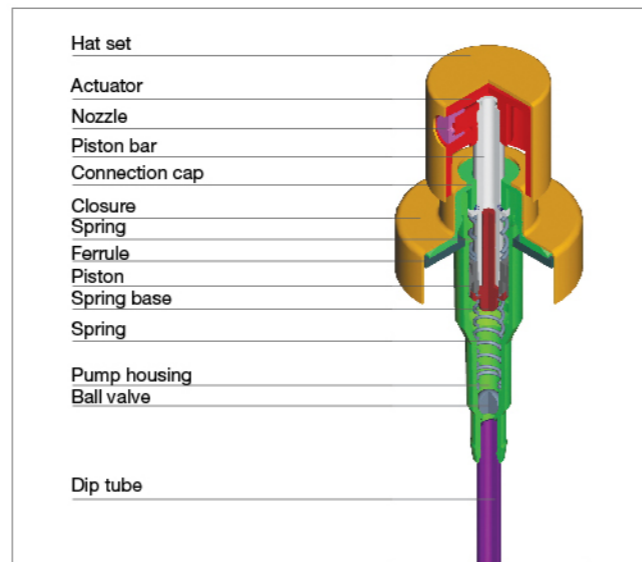

Item	Output	Qty/CTN(pcs)	Meas.(cm)
ST3010	0.15CC	2500	45.5x38x44
ST3011	0.15CC	2500	45.5x38x44
ST3012	0.15CC	2500	45.5x38x44
ST3013	0.15CC	2500	45.5x38x44
ST3014	0.15CC	2500	45.5x38x44
ST3030	0.15CC	2500	45.5x38x44
ST3040	0.15CC	2500	45.5x38x44
ST3050	0.15CC	2500	45.5x38x44
ST3051	0.15CC	2500	45.5x38x44
ST3060	0.15CC	2500	45.5x38x44
ST3061	0.15CC	2500	45.5x38x44

Others.



Clip B

Output



0.15CC

Output 0.15CC.



TIRRIT® » Perfume Sprayer

ST3020 0.07CC Low Profile

- Our crimping mist sprayer is available in range of $\Phi 15, 18, 20$ mm closure dimensions, normal and low profile and 0.15cc & 0.1cc output for options.
- To avoid carelessly depression of the actuator, we offer plastic safety clip of options.



Compatibility

Compatibility testing is recommended if there are questions or concerns. TIRRIT offers complete laboratory testing assistance and provides recommendations to assist customers with their final packaging decision.

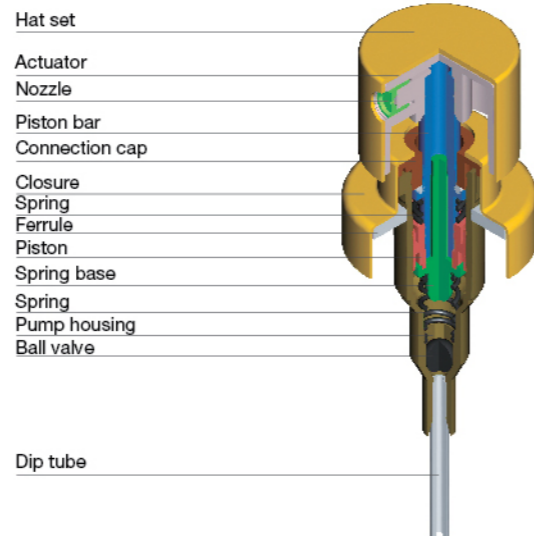

Crimp.



Screw.

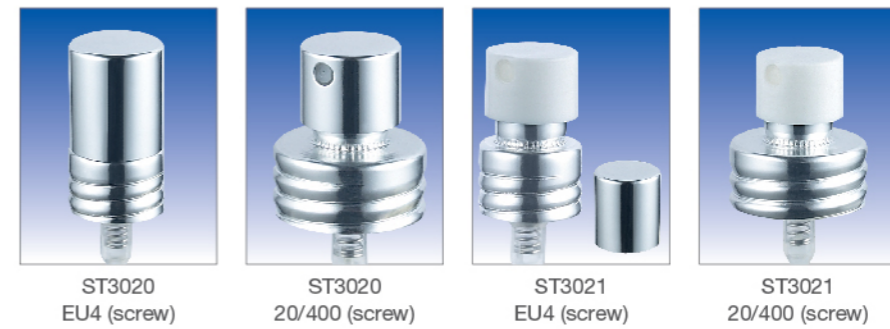

Crimless.



Output.



Others.



Item	Output	Qty/CTN(pcs)	Meas.(cm)
ST3020	0.08CC	2500	45.5x38x44
ST3021	0.08CC	2500	45.5x38x44

TIRRIT[®]
 >> Perfume Sprayer

ST307 0.07CC Low Profile

- Our crimp mist sprayer is available in range of FEA13,15,18,20mm closure dimensions, normal and low profile and 0.07cc output for options.
- To avoid carelessly depression of the actuator, we offer plastic safety clip of options.

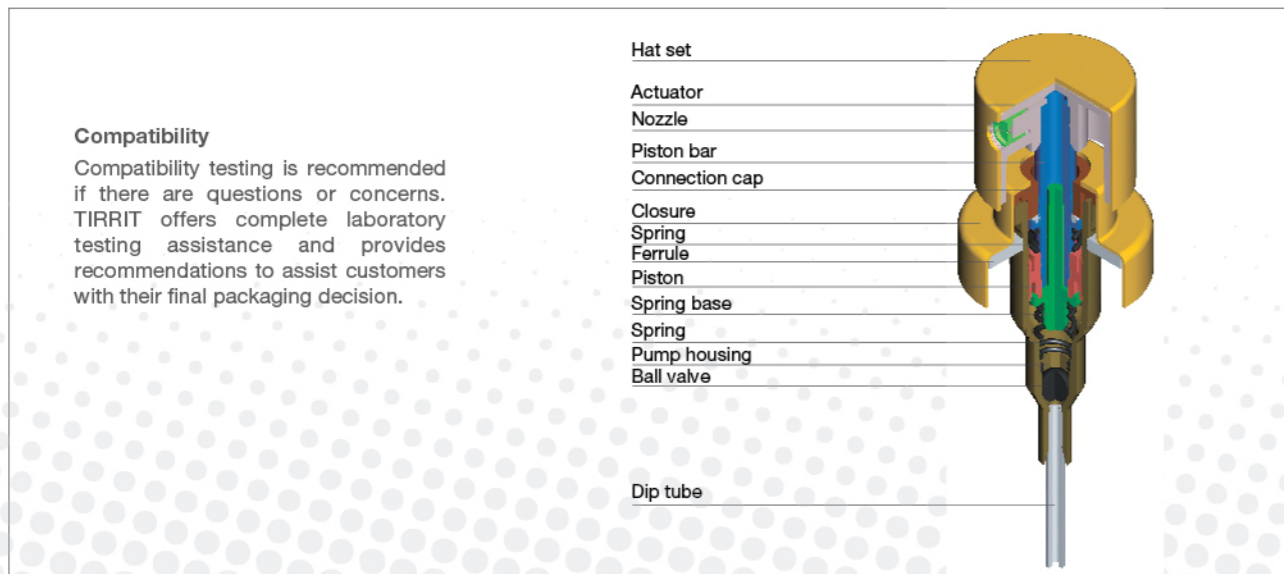

ST307 0.07CC Low Profile

Crimp.



Screw.



Crimless.

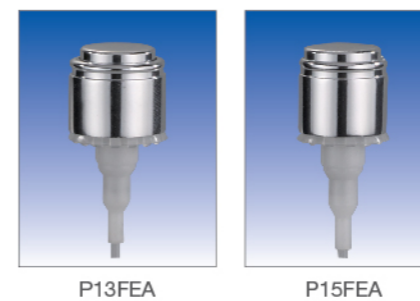

Options.



Item	Output	Qty/CTN(pcs)	Meas.(cm)
Crimp	0.07CC	3000pcs	45.5x38x44
Screw	0.07CC	2500pcs	45.5x38x44
Crimless	0.07CC	2500pcs	45.5x38x44

TIRRIT®

» Powder Pump

for Crimp bottle neck



Actuator.



ST6006 Φ20mm crimp pump

- Diameter: Ø 13 mm & 20mm;
- Output: 0.006g
- Aluminium closure ;

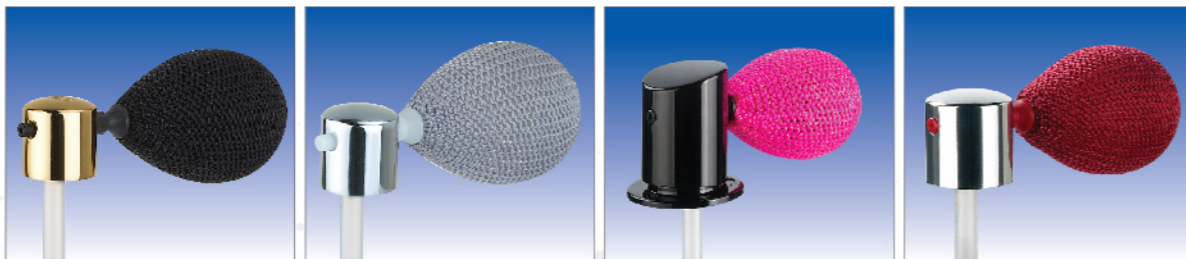

ST6002 Φ13mm crimp pump

ST6007 Φ13mm crimp pump

ST6009 Φ15mm crimp pump

Output.



0.006g

Item	Output	Qty/CTN(pcs)	Meas.(cm)
ST6002	0.006g	350pcs	39x29x31
ST6006	0.006g	300pcs	39x29x31
ST6007	0.006g	300pcs	39x29x31
ST6009	0.006g	300pcs	39x29x31

TIRRIT®

» Perfume Pump

for screw bottle neck

- Closure: 18/410
- Output: 0.03ml
- Aluminium closure ;
- Long hose and tassel for option

Actuator.



ST6004A 18/410

ST6004B 18/410



ST6004C 18/410

Output.



0.03ml

Item	Output	Qty/CTN(pcs)	Meas.(cm)
ST6004A	0.03ml	350pcs	39x29x31
ST6004B	0.03ml	330pcs	39x29x31
ST6004C	0.03ml	300pcs	39x29x31



TIRRIT®

» Cosmetic Dispenser

(0.18CC 0.25CC 0.50CC)



Compatibility

Compatibility testing is recommended if there are questions or concerns. TIRRIT offers complete laboratory testing assistance and provides recommendations to assist customers with their final packaging decision.

Output 0.18CC.

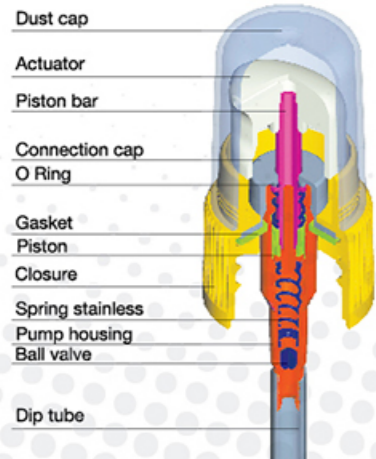

Output 0.25CC.

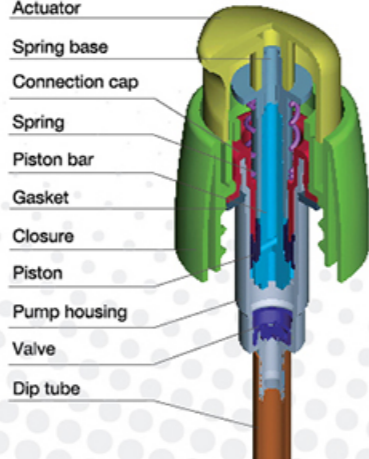

Output 0.5CC.

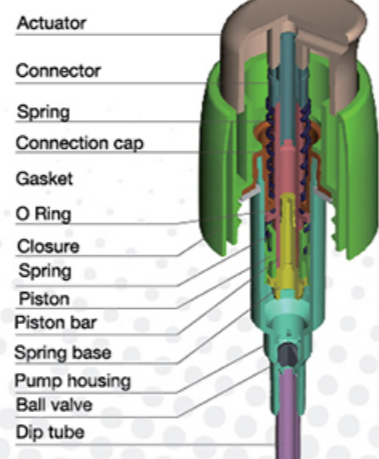

» 0.18CC Cosmetic Dispenser



ST4050
20/410



ST4051
20/410



ST4052
20/410



ST4056
20/410



ST4056
22/415



ST4056
24/410



ST4056
24/415



ST40562
20/410



ST40562
20/410



ST40562
22/415



ST40562
24/410



ST40562
24/415



ST40562
24/410



metal collar



metal collar

Item	Output	Qty/CTN(pcs)	Meas.(cm)
ST4050	0.17-0.2CC	2000	45.5x38x44
ST4051	0.17-0.2CC	2000	45.5x38x44
ST4052	0.17-0.2CC	2000	45.5x38x44
ST4056	0.18CC	2000	45.5x38x44
ST40562	0.18CC	2000	45.5x38x44

» 0.18CC Cosmetic Dispenser



Item	Output	Qty/CTN(pcs)	Meas.(cm)
ST40563	0.18CC	2000	45.5x38x44
ST40564	0.18CC	2000	45.5x38x44
ST40572	0.18CC	2500	45.5x38x44



» 0.18CC Cosmetic Dispenser



Item	Output	Qty/CTN(pcs)	Meas.(cm)
ST40572	0.18CC	2000	45.5x38x44
ST4058	0.18CC	2000	45.5x38x44
ST4059	0.18CC	2000	45.5x38x44
ST4060	0.18CC	2000	45.5x38x44
ST4062	0.18CC	2000	45.5x38x44

» 0.25CC Cosmetic Dispenser
(No Metal Contact)

» ST415 0.25CC



» 0.5CC Cosmetic Dispenser
(No Metal Contact)

» ST416 0.5CC



Closure. 24/410

Item	Output	Qty/CTN(pcs)	Meas.(cm)
ST416	0.5CC	2000pcs	45.5x38x44

TIRRIT®

» Lotion Pump Left-right Lock

Compatibility

Compatibility testing is recommended if there are questions or concerns. TIRRIT offers complete laboratory testing assistance and provides recommendations to assist customers with their final packaging decision.

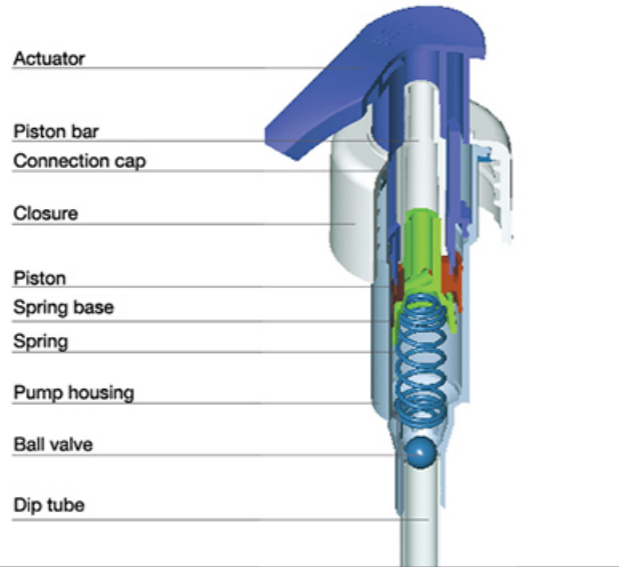

» ST4012

- ST4012
- ST4012B
- ST40122
- ST40123
- ST40124
- ST40125
- ST40127
- ST40128
- ST40129



Item	Output	Qty/CTN(pcs)	Meas.(cm)
ST4012	1.3-1.5CC	1160	57x37x45
ST4012B	1.3-1.5CC	1000	57x37x45
ST40122	1.3-1.5CC	1000	57x37x45
ST40123	1.3-1.5CC	1020	57x37x45
ST40124	1.3-1.5CC	1100	57x37x45
ST40125	1.3-1.5CC	1000	57x37x45
ST40127	1.3-1.5CC	1200	57x37x45
ST40128	1.3-1.5CC	1160	57x37x45
ST40129	1.3-1.5CC	1160	57x37x45

Actuator.



Closure.



Output.



Others.

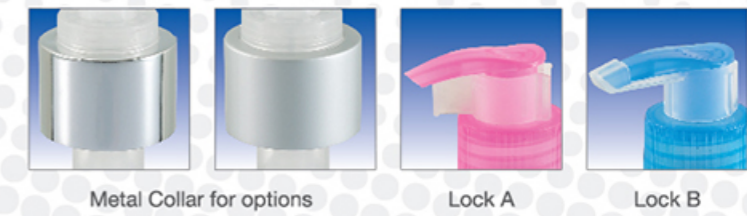

TIRRIT®

» Lotion Pump Screw Down Lock

Compatibility

Compatibility testing is recommended if there are questions or concerns. TIRRIT offers complete laboratory testing assistance and provides recommendations to assist customers with their final packaging decision.

Actuator

Piston bar

Connection cap

Closure

Piston

Spring base

Spring

Pump housing

Ball valve

Dip tube

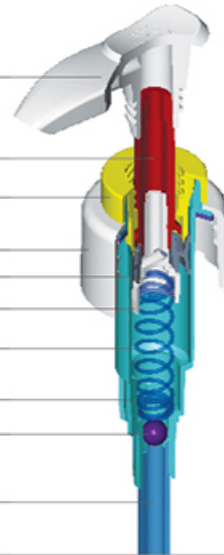

» ST4011

- ST4011
- ST40112
- ST4013
- ST4014
- ST4014AB
- ST4015
- ST4015A
- ST4017
- ST4017-2
- ST40173
- ST4018
- ST4019



Item	Output	Qty/CTN(pcs)	Meas.(cm)
ST4011	2.0CC	1250	57x37x45
ST4013	2.0CC	1000	57x37x45
ST40112	2.0CC	1000	57x37x45
ST4014	2.0CC	1000	57x37x45
ST4014AB	2.0CC	1000	57x37x45
ST4015	2.0CC	970	57x37x45
ST4015A	2.0CC	970	57x37x45
ST4017	2.0CC	600	57x37x45
ST4017-2	2.0CC	600	57x37x45
ST40173	2.0CC	600	57x37x45
ST4018	2.0CC	1000	57x37x45
ST4019	2.0CC	1000	57x37x45

Actuator.



ST4011



ST4015



ST4015A



ST4018



ST4019



ST4017



ST4017-2



ST40173

Closure.

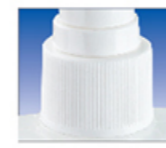

24/410 Ribbed



24/410 Smooth



24/415 Ribbed



28/400



28/405



28/410 Ribbed



28/410 Smooth



28 BPF



28/415 Ribbed



28/415 Smooth



28 Ratchet

Output.



2.0CC

Others.



Metal Collar for options

» No Metal Contact Pump
Screw down lock

Compatibility

Compatibility testing is recommended if there are questions or concerns. TIRRIT offers complete laboratory testing assistance and provides recommendations to assist customers with their final packaging decision.

Actuator

Nozzle

Piston bar

Connection cap

Closure

Spring

Piston

Spring base

Pump housing

Ball valve

Dip tube

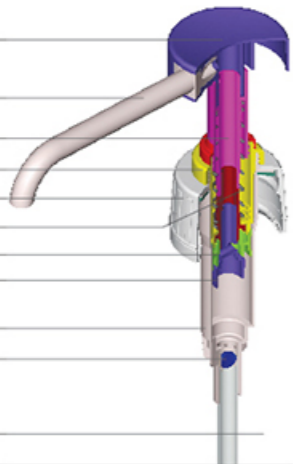

Item	Output	Qty/CTN(pcs)	Meas.(cm)
ST4100/ST4110	2CC/3CC	600	57X37X45
ST4101/ST4111	2CC/3CC	1000	57X37X45
ST4012/ST4112	2CC/3CC	1000	57X37X45
ST4103/ST4113	2CC/3CC	600	57X37X45
ST4103-2/ST4113-2	2CC/3CC	600	57X37X45
ST4104/ST4114	2CC/3CC	1000	57X37X45
ST4105/ST4115	2CC/3CC	1000	57X37X45
ST4107/ST4117	2CC/3CC	1000	57X37X45
ST4108/ST4118	2CC/3CC	1000	57X37X45
ST4109/ST4119	2CC/3CC	1000	57X37X45

» No Metal Contact Pump
Screw down lock

2CC.

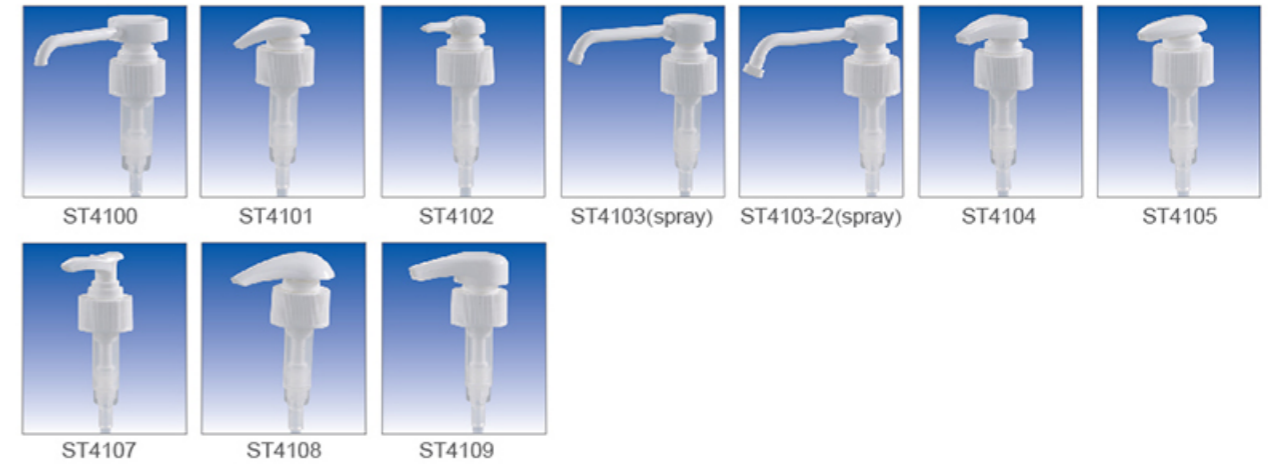

3CC.



Closure.



Output.

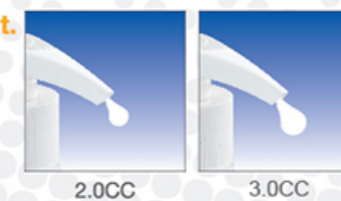

» No Metal Contact Pump
Left-right up lock

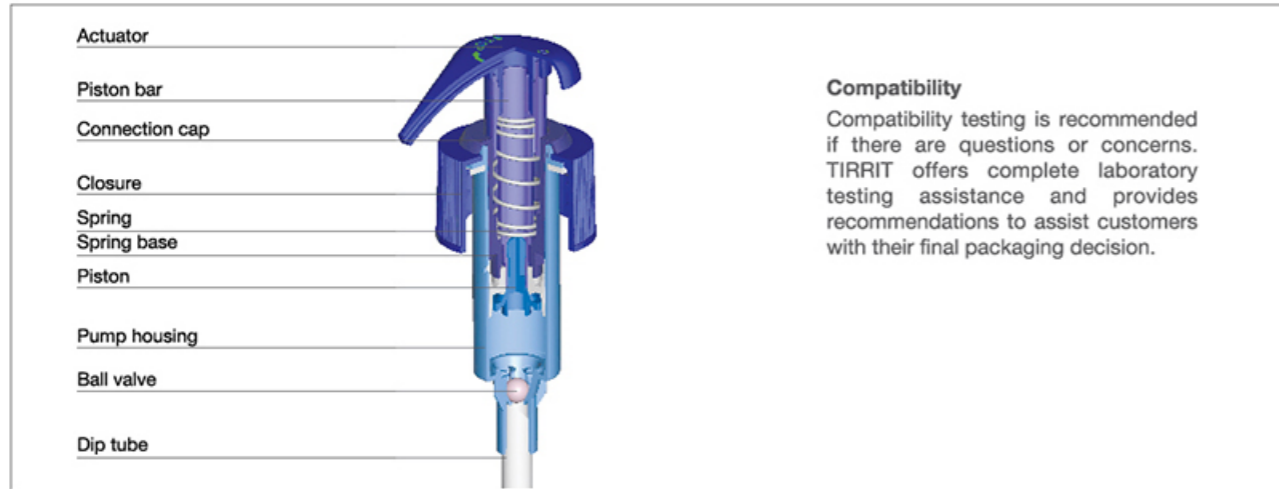

Model.



Closure.



Output.



Item	Output	Qty/CTN(pcs)	Meas.(cm)
ST4120	2.0CC	1000	57x37x45
ST4122	2.0CC	1000	57x37x45
ST4124	2.0CC	1000	57x37x45
ST4125	2.0CC	1000	57x37x45

TIRRIT[®]
Lotion Pump

ST4030

- High-output 3.0-3.5cc
- Actuator direction oriented.

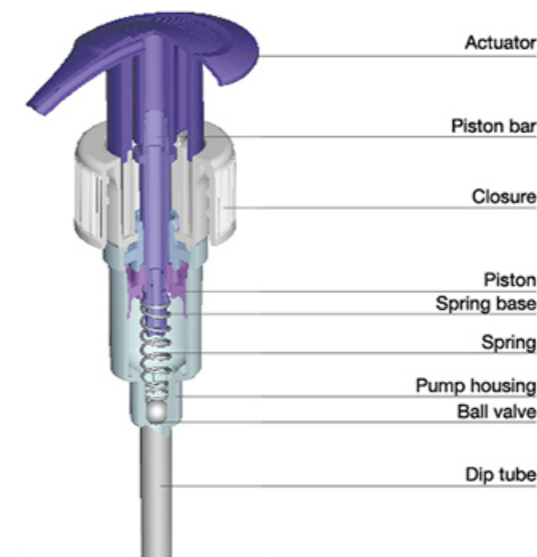

Actuator.



Closure.



Output.



Item	Output	Qty/CTN(pcs)	Meas.(cm)
ST4030	2.3-2.5CC	1000	57x37x45

TIRRIT® Lotion Pump

ST4020

- High-output 3.0-3.5cc
- ST4020 lotion pump is for high-output applications like shampoos, conditioners and body washes.

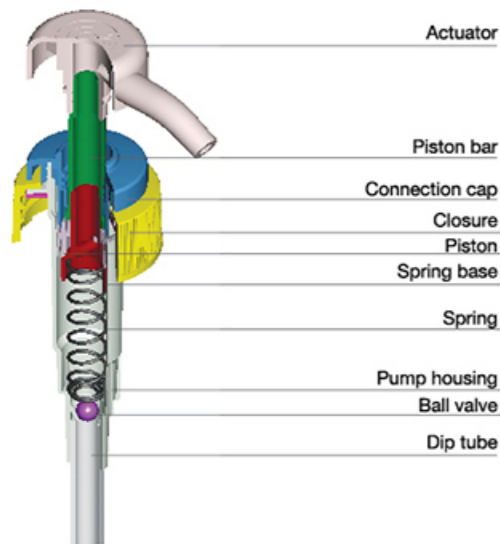

» No Metal Contact Pump
Screw down lock

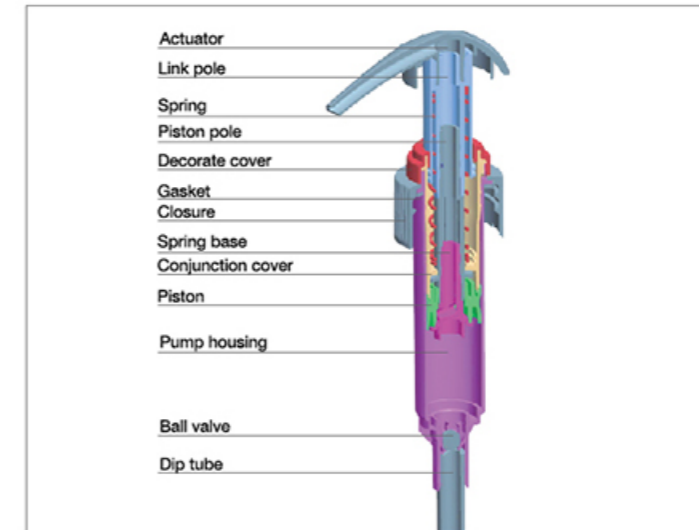

Item	Output	Qty/CTN(pcs)	Meas.(cm)
ST4020	3.0-3.5CC	1000	57x37x45



Item	Output	Qty/CTN(pcs)	Meas.(cm)
ST4130	5CC	600	57x37x45
ST4131	5CC	600	57x37x45
ST4132	5CC	600	57x37x45
ST4133	5CC	600	57x37x45
ST4134	5CC	600	57x37x45
ST4135	5CC	600	57x37x45

Option. 4CC is available

» No Metal Contact Pump
Screw down lock

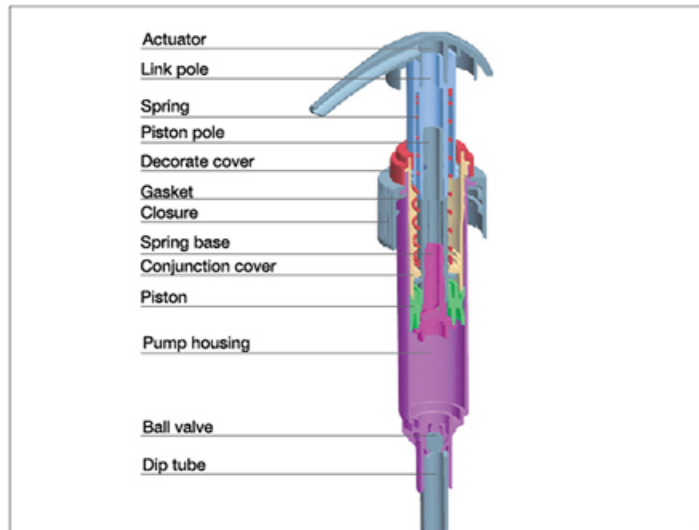

TIRRIT[®]
» Gallon Pump

ST4040 High-output gallon pump

- Screw down lock head configuration prevents "pop-up" during shipment.
- ST4040 series with discharge rate 10ml/ 15ml/ 20ml/ 25ml/ 30ml and deliver consistent, reliable performance across a full range of applications.
- This series pump are designed to work with various high-output formulations, including liquid soaps, lotions, shampoos and conditioners and sauce dispensing.

Actuator.



Output.



Closure.



Item	Output	Qty/CTN(pcs)	Meas.(cm)
ST4140	10CC	600	57x37x45
ST4141	10CC	600	57x37x45
ST4142	10CC	600	57x37x45
ST4143	10CC	600	57x37x45
ST4144	10CC	600	57x37x45
ST4145	10CC	600	57x37x45
ST4180	8CC	600	57x37x45

Option. 8CC is available



TIRRIT[®]

» Gallon Pump

» ST4040 Series

ST4040

ST4041

ST4042

Compatibility

Compatibility testing is recommended if there are questions or concerns. TIRRIT offers complete laboratory testing assistance and provides recommendations to assist customers with their final packaging decision.



- Actuator
- Nozzle
- Piston bar
- Connection cap
- Closure
- Spring
- Pump housing
- Spring base
- Ball valve
- Dip tube

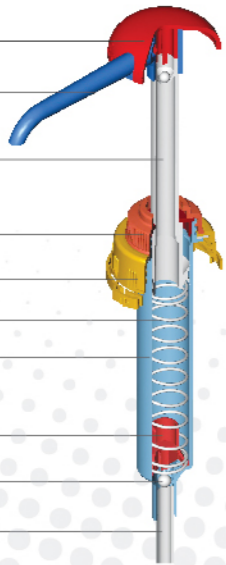

Actuator.



ST4040



ST4041



ST4042

Closure.



38/400



38/410



43/400



45/400

Output.



10ml



15ml



20ml



25ml



30ml

Others.



Printing for options

Item	Output	Qty/CTN(pcs)	Meas.(cm)
ST4040	10/15/20/25/30 CC	200	57x37x45
ST4041	10/15/20/25/30 CC	200	57x37x45
ST4042	10/15/20/25/30 CC	200	57x37x45

>> Foam Pump

ST5001 Series

- The unique air-and-liquid mixing system used.
- Foamer gently dispenses your product into the rich foam consumers expect.
- For a better life,an easier environment.
- Many kinds of head and closure for options.



- | | |
|--------|--------|
| ST5001 | ST5012 |
| ST5002 | ST5013 |
| ST5003 | ST5014 |
| ST5010 | ST5015 |
| ST5011 | ST5016 |

Model.



Output.

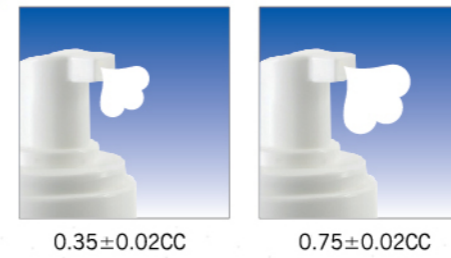

Item	Output	Qty/CTN(pcs)	Meas.(cm)
ST5001	0.35±0.02cc	700	57×37×49
ST5002	0.35±0.02cc	700	57×37×49
ST5003	0.35±0.02cc	700	57×37×49
ST5010	0.75±0.02cc	400	57×37×49
ST5011	0.75±0.02cc	400	57×37×49
ST5012	0.75±0.02cc	400	57×37×49
ST5013	0.75±0.02cc	400	57×37×49
ST5014	0.75±0.02cc	400	57×37×49
ST5015	0.75±0.02cc	400	57×37×49
ST5016	0.75±0.02cc	400	57×37×49

TIRRIT®

Trigger Sprayer

ST105

- Different mechanical instruction can prevent dip-tube move up and down while trigger priming. This design could help customer to use liquid completely.
- Its stable reliability and also available for a variety of applications with household, automotive, garden, industrial and personal care products.
- Customize spray-stream-foam nozzle configurations, as well as many kinds of shrouds and closures.



Compatibility

Compatibility testing is recommended if there are questions or concerns. TIRRIT offers complete laboratory testing assistance and provides recommendations to assist customers with their final packaging decision.

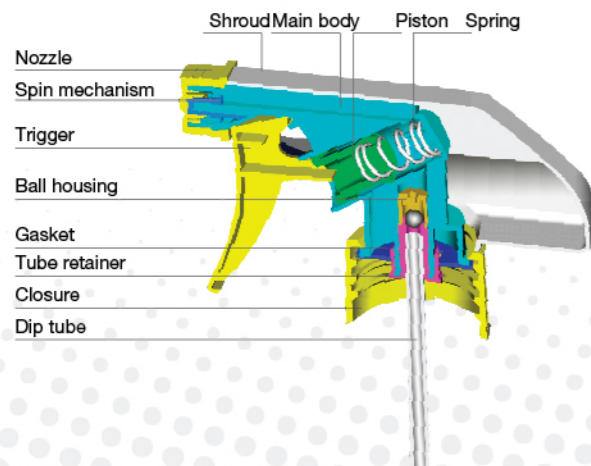

Shroud.



ST1050

ST1051

ST1052



ST1053

ST1054

ST1055



ST1056

ST1059

Output.

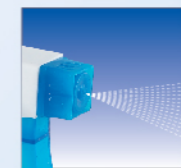

0.8CC

Closure.



DIN 28

28/400

28/410

28/415

Nozzle Options.

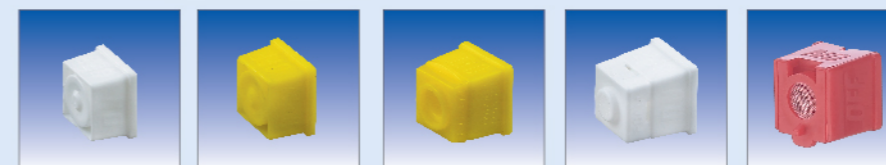

Spray Only

Spray / Stream

Spray / Foamer

Mesh Foamer

Spray Foam

Item	Output	Qty/CTN(pcs)	Meas.(cm)
ST1050	0.8CC	530	57x37x45
ST1051	0.8CC	500	57x37x45
ST1052	0.8CC	500	57x37x45
ST1053	0.8CC	500	57x37x45
ST1054	0.8CC	500	57x37x45
ST1055	0.8CC	500	57x37x45
ST1056	0.8CC	500	57x37x45

Compatibility

Compatibility testing is recommended if there are questions or concerns. TIRRIT offers complete laboratory testing assistance and provides recommendations to assist customers with their final packaging decision.

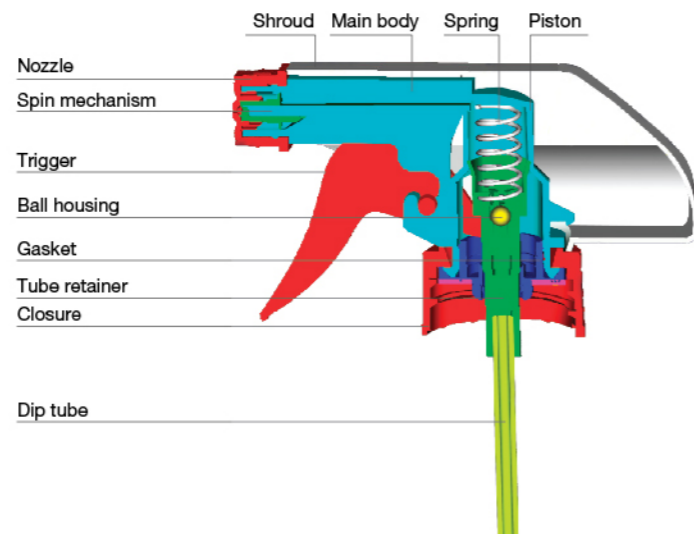

>> ST106 Series

- ST1060
- ST1061
- ST1063
- ST1064
- ST1065
- ST1066



Shroud.



Closure.

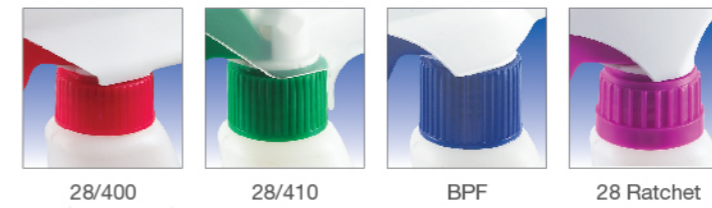

Nozzle Options.

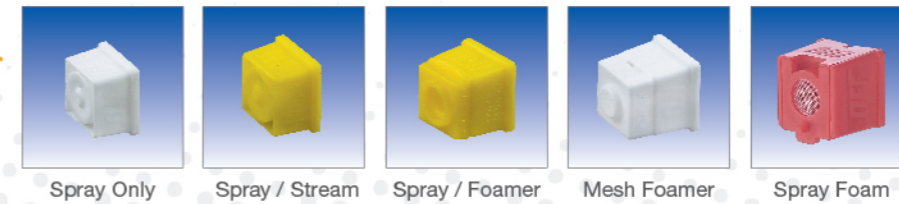

Output.



Others.



Item	Output	Qty/CTN(pcs)	Meas.(cm)
ST1060	0.9CC	650	57x37x45
ST1061	0.9CC	650	57x37x45
ST1063	0.9CC	700	57x37x45
ST1064	0.9CC	650	57x37x45
ST1065	0.9CC	750	57x37x45
ST1066	0.9CC	650	57x37x45
ST1067	0.9CC	650	57x37x45
ST1068	0.9CC	650	57x37x45

TIRRIT®

» Trigger Sprayer

ST1010

- They're perfect for a wide range of applications including lawn, garden and laundry.
- With an adjustable nozzle, these trigger can offer spray and stream function. In addition to the standard configuration, the ST1031 can be fit with brass nozzle for long term using.



Compatibility

Compatibility testing is recommended if there are questions or concerns. TIRRIT offers complete laboratory testing assistance and provides recommendations to assist customers with their final packaging decision.

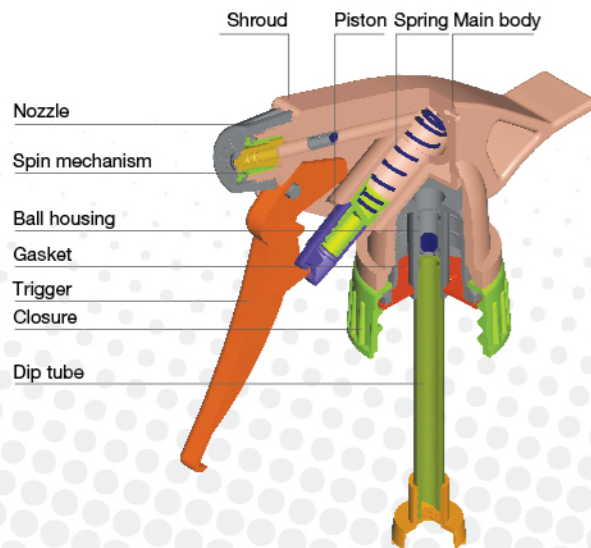

Shroud.



ST1010



Foamer



ST1030



ST1031



ST1040

Closure.



28/400



28/410

Nozzle Options.



Adjustable Nozzle



Brass Nozzle



Foamer Nozzle

Output.



0.9 ± 0.1CC
(ST1030 & ST1040)



1.1 ± 0.1CC
(ST1010 & ST1031)

Item	Output	Qty/CTN(pcs)	Meas.(cm)
ST1010	1.1CC	460	57x37x45
ST1030	0.9CC	480	57x37x45
ST1031	1.1CC	430	57x37x45
ST1040	0.9CC	510	57x37x45

TIRRIT[®] Trigger Sprayer

ST107

- They're perfect for a wide range of applications including garden and laundry.
- In addition to the standard configuration, the ST1072 & ST1074 Remote with weighted tube end, which can be more convenient for using.
- Big discharge rate 1.3cc +/-0.1cc per stroke.



Compatibility

Compatibility testing is recommended if there are questions or concerns. TIRRIT offers complete laboratory testing assistance and provides recommendations to assist customers with their final packaging decision.

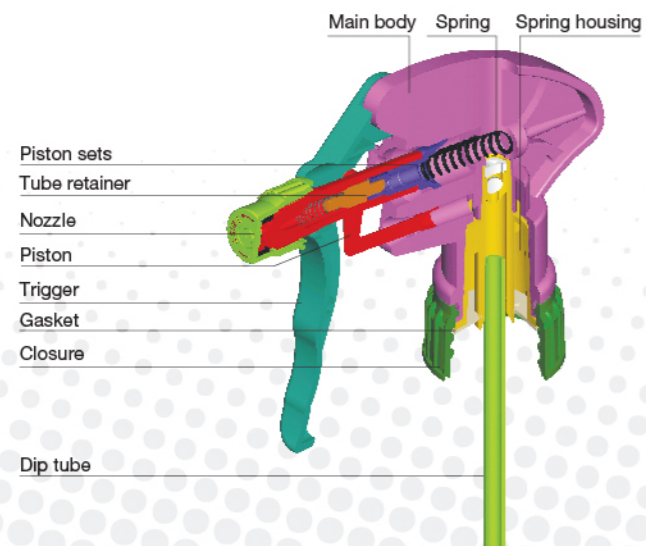

Model.



ST1070



ST1071



ST1072



ST1074

Closure.



28/400



28/410

Output.



1.3CC

Item	Output	Qty/CTN(pcs)	Meas.(cm)
ST1070	1.3CC	500	57x37x45
ST1071	1.3CC	500	57x37x45
ST1072	1.3CC	200	57x37x45
ST1074	1.3CC	200	57x37x45

TIRRIT®

Trigger Sprayer



TR3000 Series

- This is new design in our company. The wide smooth-pull trigger combines a compact stroke with high output performance.
- They're perfect for a wide range of applications including lawn, garden and laundry.
- The various large nozzles provide spray/stream, spray /foam, mesh foam, spray brush and child resistant for added safety.
- Combined with different shroud bring you modern look that greater performance on a wider range.
- In addition to the standard configuration, the TR3100 Remote, which can be sprayed for long distance, is also available for a variety of applications.
- Patented.

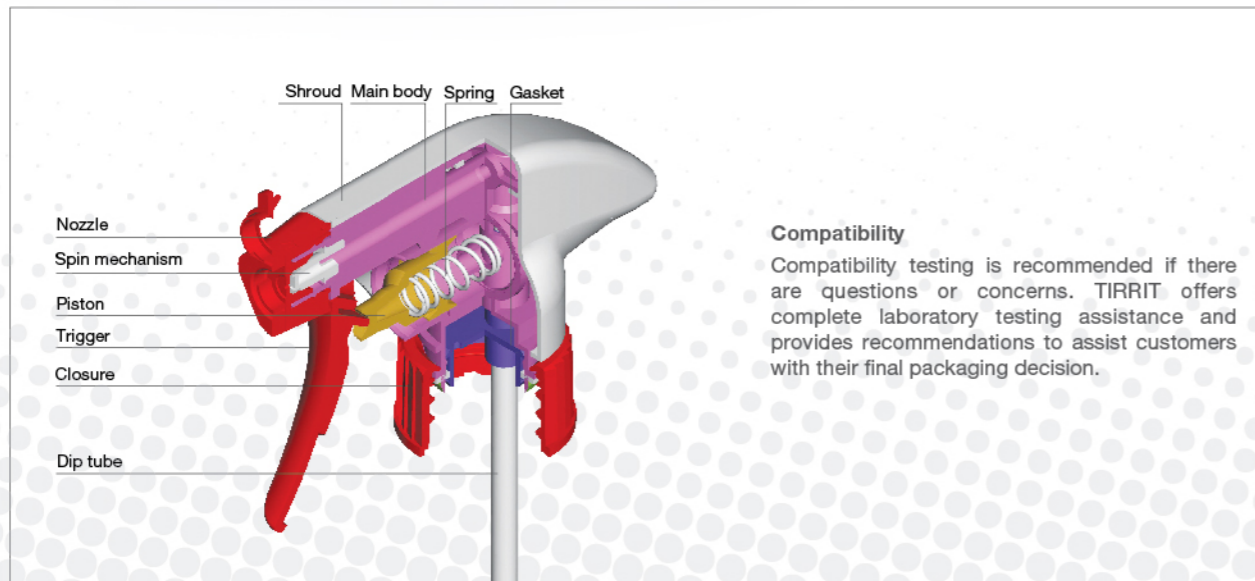

Compatibility

Compatibility testing is recommended if there are questions or concerns. TIRRIT offers complete laboratory testing assistance and provides recommendations to assist customers with their final packaging decision.

Shroud.



Closure.

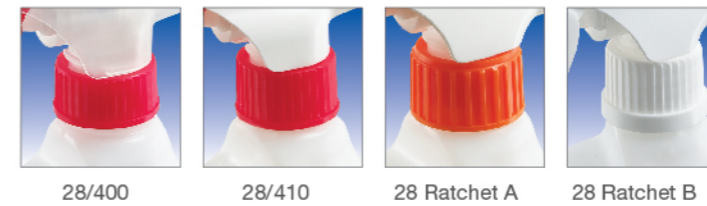

Nozzle Options.



Output.



Others.



Item	Output	Qty/CTN(pcs)	Meas.(cm)
Brush Trigger	1.4CC	450	57x37x45
TR3000	1.4CC	500	57x37x45
TR3001	1.4CC	500	57x37x45
TR3002	1.4CC	500	57x37x45
TR3003	1.4CC	500	57x37x45
TR3100	1.4CC	150	57x37x45
TR341	1.2CC	420	57x37x45
TR342	1.2CC	420	57x37x45
TR343	1.2CC	500	57x37x45



XXS-Mini Pack

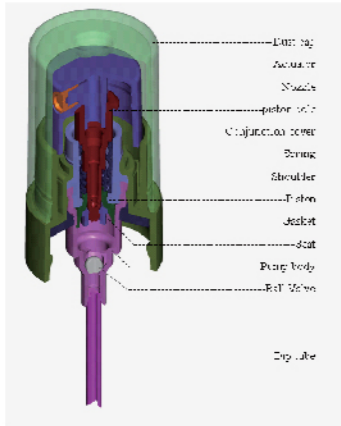

SNAP ON

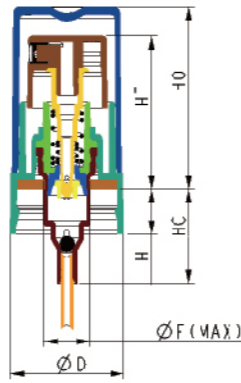

Screw

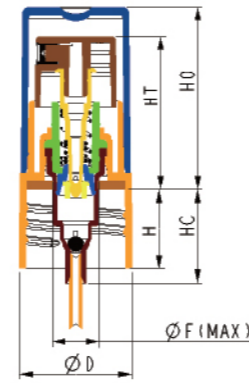

OPTION



Sprayer Actuator Lotion Actuator Pouch Spout



	DIAMETER	DOSAGES	DIMENSIONS				HT VALUE			OPTION	
			D	H	HC	HO	Sprayer Actuator	Lotion Actuator	Pouch Spout		
Crimp	11	0.06CC	12.00	5.05	12.20		19.9	19.9			
	13	0.06CC	14.70	5.80	12.20	23.70	19.9	19.9			
Screw	M11	0.06CC	12.00	4.60	16.60		15.5	15.5	★		
	13/415	0.06CC	14.70	10.30	12.20	23.70	19.9	19.9			

ALL F=6.1mm

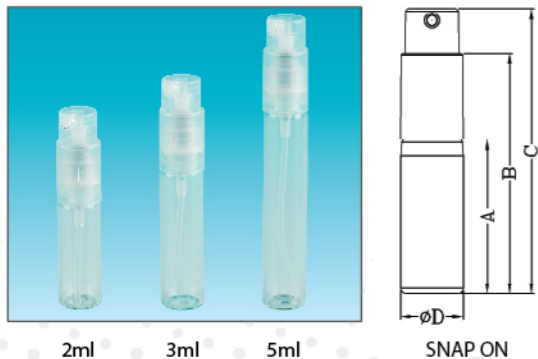

2ml 3ml 5ml SNAP ON

XXS-1

Capacity	A	B	C	D
2ml	29.50	46.00	54.50	12.00
3ml	38.50	55.00	63.50	12.00
5ml	54.50	71.00	79.50	12.00

Bottle Materials:Glass

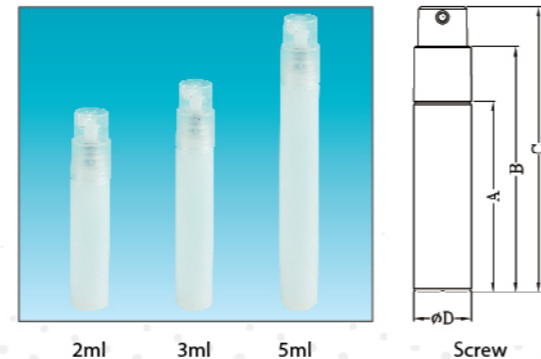

2ml 3ml 5ml Screw

XXS-2

Capacity	A	B	C	D
2ml	31.40	43.00	51.50	12.00
3ml	40.40	52.00	60.50	12.00
5ml	56.40	68.00	76.50	12.00

Bottle Materials:HDPE- PP



5ml 8ml 10ml SNAP ON

XXS-3

Capacity	A	B	C	D
5ml	46.40	54.40	75.90	15.00
8ml	67.40	75.40	96.90	15.00
10ml	82.40	90.40	111.90	15.00

Bottle Materials:Glass



5ml 8ml 10ml Screw

XXS-4

Capacity	A	B	C	D
5ml	57.00	69.50	90.00	15.00
8ml	93.00	105.50	126.00	15.00
10ml	115.00	127.50	148.00	15.00

Bottle Materials:PP

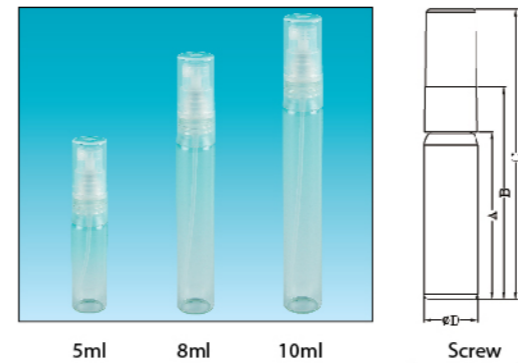

5ml 8ml 10ml Screw

XXS-5

Capacity	A	B	C	D
5ml	46.70	59.20	80.70	15.00
8ml	67.70	80.20	101.70	15.00
10ml	82.70	95.20	116.70	15.00

Bottle Materials:Glass



Dropper

Closure.



18/415-1



18/415-2



18/415-3



18/415-4



18/400



20/400



20/410

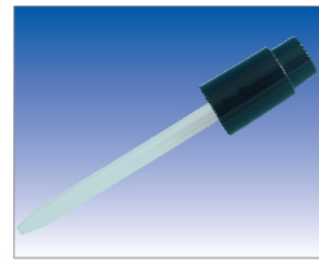

QT4005-18/400 plastic tube

Options.



Metal collar

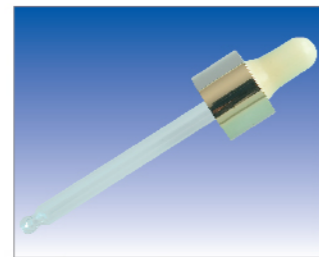

Smooth bubble



Matt bubble

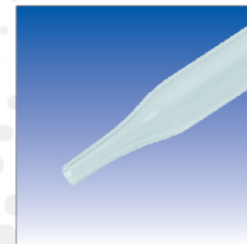

Pointed head



Round head

Flip Top



CP1001
24/415



CP1001
28/415



CP1003
24/410



CP1004
24/410



CP1004
28/415



CP1006
24/410



CP1006
24/415



CP1006
15/415



CP1007
28/400 28/410

Disc Top

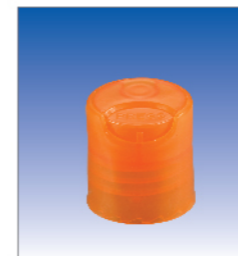

CP1020
20/410



CP1020
20/415



CP1020
24/410



CP1020
24/415



CP1020
28/410



CP1020
28/415

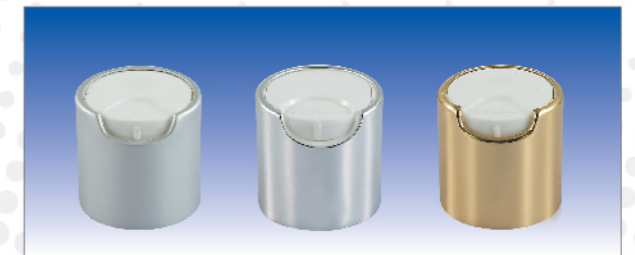

CP1020 w/ metal collar
(24/410 24/415 28/410 28/415)

Push Pull



CP1033
28/410



CP1033
28/410 (4 holes)



CP1033
24/410 (4 holes)



CP1033
24/410

Twist



CP1038
20/410 24/410 28/410

CT

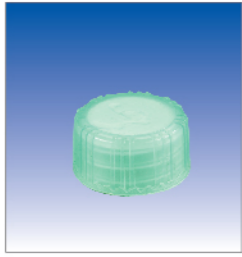

CP1040
18/400



CP1041
20/410



CP1042
24/410



CP1043
28/410



CP1043
24/410



CP1050
Φ16

CP1050
Φ18

CP1050
Φ20



CP1052
16/415

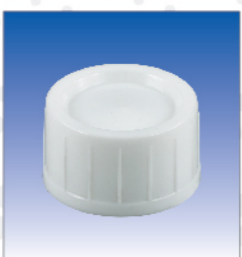

CP1066
28/410



CP1070
M28



CP1070
M28

CT

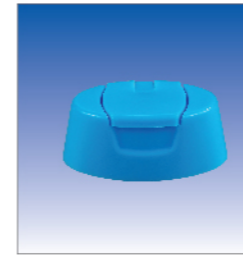

CP1055
Φ16
A44 x B22.5 x H17



CP1055
Φ22
A61 x B32.5 x H26

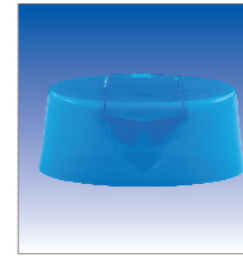

CP10552
Φ22
A69 x B36 x H28.2



CP1058
Φ22
A51 x B34 x H28.5



CP1054
24/415



CP1064
DIA 10.8mm



CP1065
24/415

CR (CP1061 CHILD RESISTANT CAP)



Child Safe
28/400



Child Safe
28/410



CP201



GL 28 Tamper Evident
Child Resistant

Other



25 ML